



Total Solution Provider in Saw Device

SA26030AD

260.0 MHz IF SAW Filter
30.21 MHz Bandwidth
Revision 0: 10. Nov. 2009



- Electrical Characteristics
 - Package Dimensions
 - Testing Environment
 - Frequency Characteristics
-

SAWNICS Inc.

460 Cheonheung-ri, Seonggeo-eup, Cheonan-si, Chungcheongnam-do, 330-836 / Korea.
Tel: +82 41 550 9372 / Fax: +82 41 550 9399 / www.sawnics.com

□ Electrical Characteristics

Maximum Ratings

Parameters Description	Unit	Minimum	Typical	Maximum
Operating Temperature Range	°C	-5	-	80
Storage Temperature Range	°C	-40	-	85
Maximum DC Voltage	V	-	-	10
Maximum Input Power	dBm	-	-	10
Source Impedance (single ended) ⁽¹⁾	Ω	-	50	-
Load Impedance (single ended) ⁽¹⁾	Ω	-	50	-
Package type & size	D			
Length x Width	mm ²	-	20.0 x 12.6	-
Height	mm	-	-	5.05

Electrical Specification

Parameters Description	Unit	Minimum	Typical	Maximum
Center Frequency (Fo)	MHz	-	260.0	-
Insertion Loss at Fo	dB	-	32.5	-
Group Delay Variation at Fo ± 14.52 MHz	nsec	-	58	80
Absolute Delay at Fo	usec	-	2.83	-
Passband Ripple Variation at Fo ± 14.52 MHz	dB	-	0.79	1.0
Bandwidth at -1dB	MHz	30.00	30.21	-
Bandwidth at -3dB	MHz	-	30.51	-
Bandwidth at -20dB	MHz	-	31.33	-
Bandwidth at -40dB	MHz	-	31.72	31.90
Ultimate Rejection	dB	50	53	-
Temperature Coefficient	ppm/°C	-	-18	-

Notes : (1) With Matching Network (Ref. Testing Environment Circuit as shown below).

Those impedances could be modified with different impedance values and/or structures, if necessary.

Package Dimensions

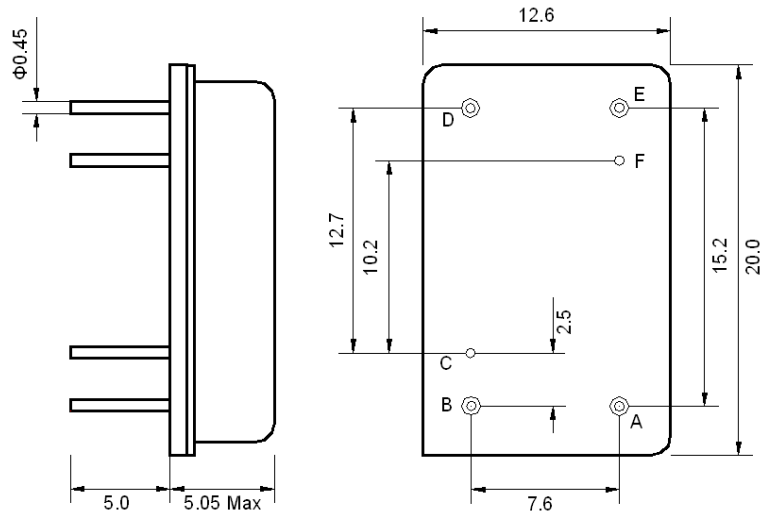

Pin Description	
B, C, D, F	Ground
A	Input
E	Output

Testing Environment

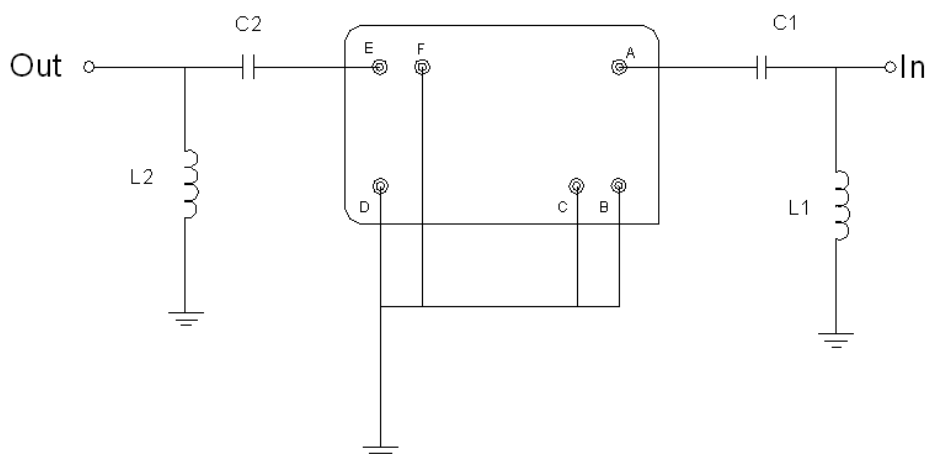

Test Fixture & Values	
Input	L1 = 6.8 nH, C1 = 200 pF
Output	L2 = 8.2 nH, C2 = 180 pF
Source/Load Impedance	50 Ω



Frequency Characteristics

Frequency Response

Bandwidth at -1.0 dB

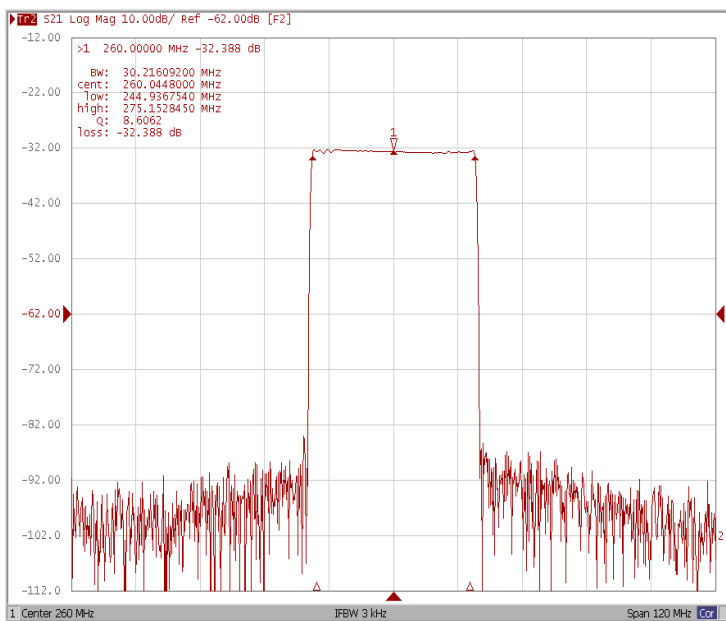

Bandwidth at -3.0 dB

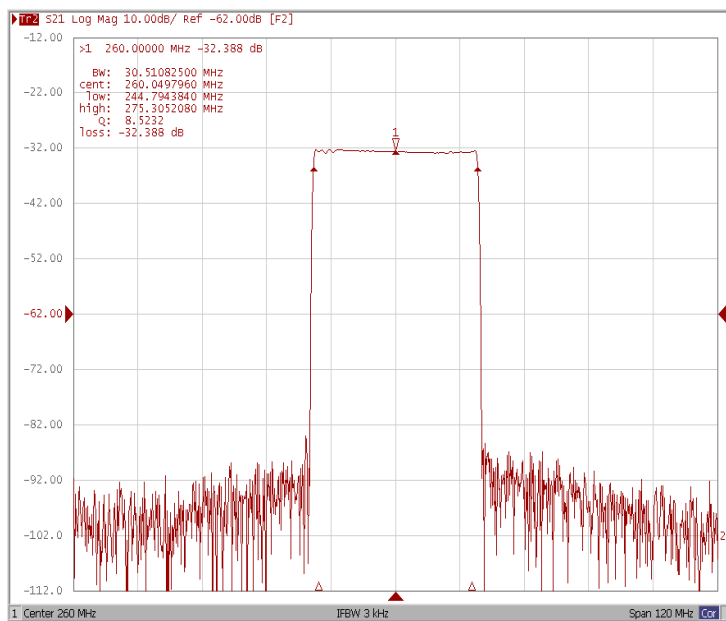

Bandwidth at -20.0 dB

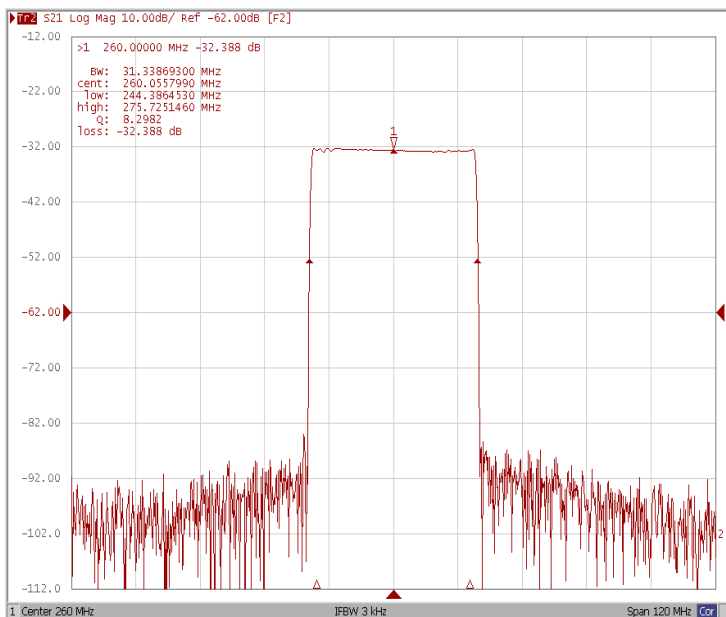

Bandwidth at -40.0 dB

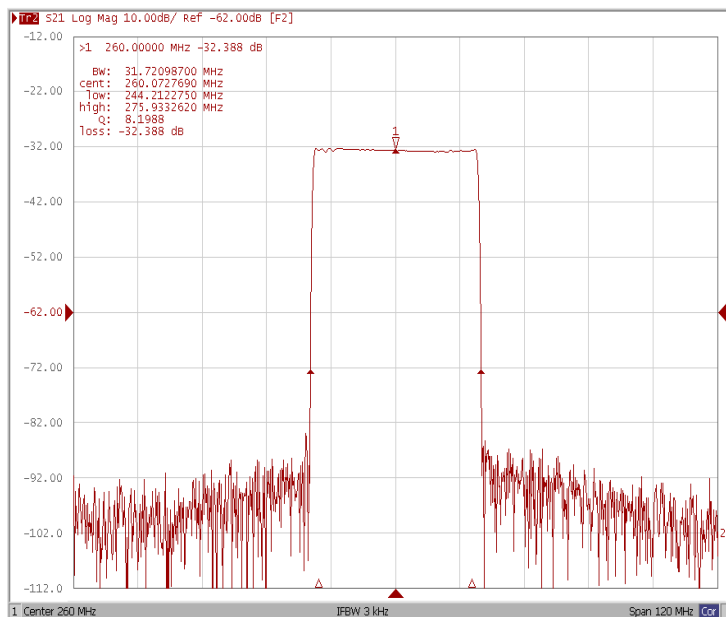



Frequency Characteristics

Frequency Response

Ripple Variation $Fo \pm 14.52\text{MHz}$

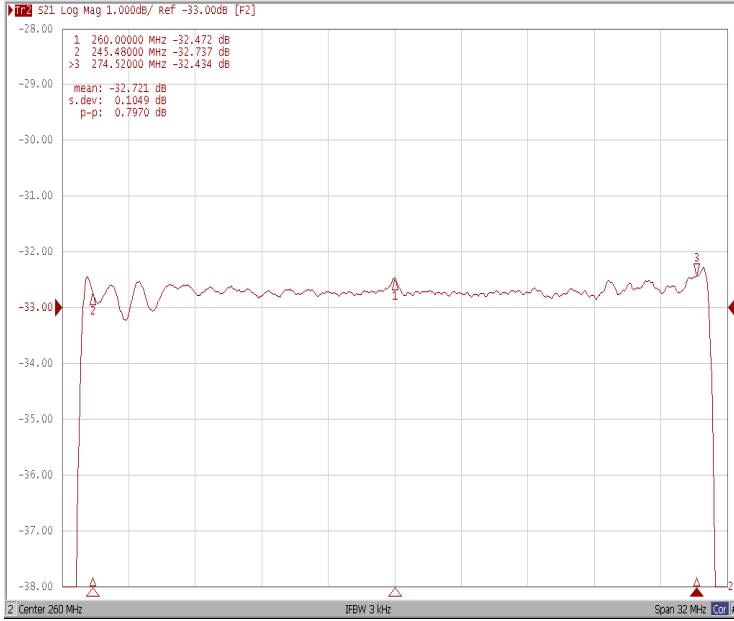

Group Delay Variation $Fo \pm 14.52\text{MHz}$

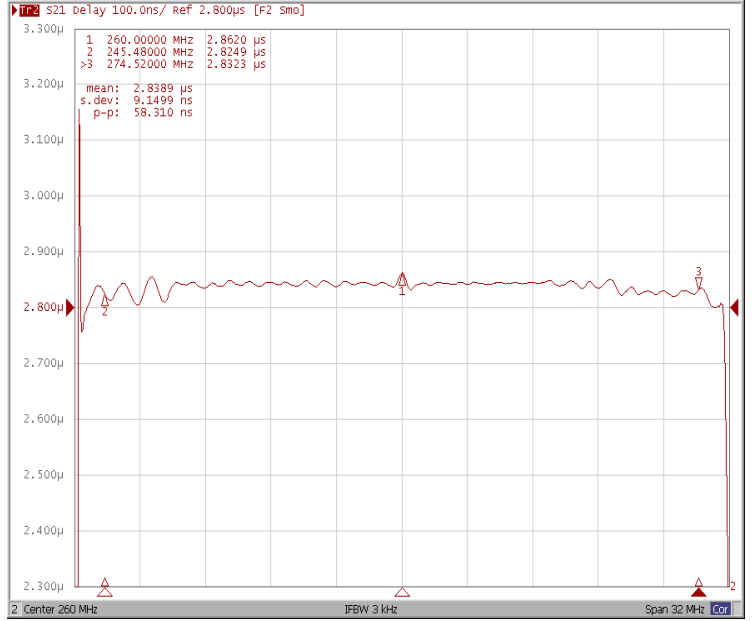

Smith Chart

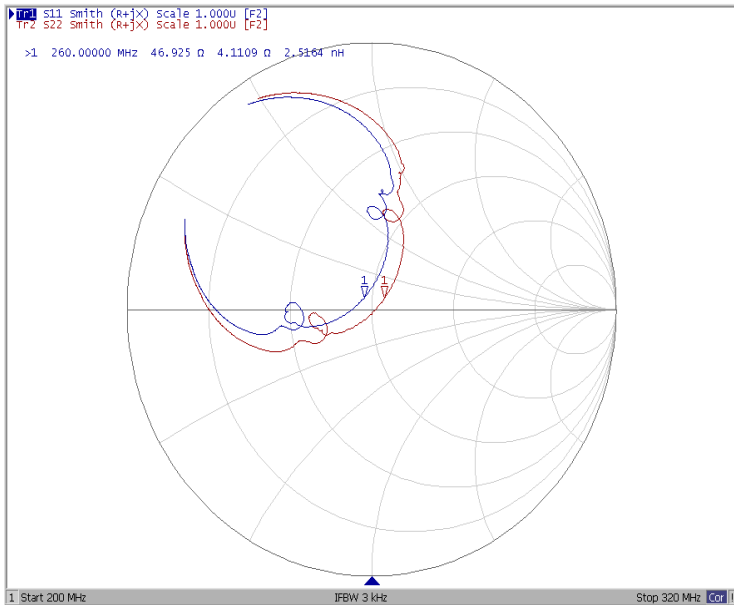

VSWR

