



*Total Solution Provider in Saw Device*

---

# SD-075104-C56

Band 13, SAW Duplexer for 751.0 / 782.0 MHz  
Revision 0: August 2014

MSD/MSL 3



- Electrical Characteristics
  - Package Dimensions
  - Testing Environment
  - Frequency Characteristics
- 

**SAWNICS Inc.**

---

460 Cheonheung-ri, Seonggeo-eup, Cheonan-si, Chungcheongnam-do, 330-836 / Korea.  
Tel: +82 41 550 9372 / Fax: +82 41 550 9399 / [www.sawnics.com](http://www.sawnics.com)



## □ Electrical Characteristics

### Maximum Ratings

Parameters Description	Unit	Minimum	Typical	Maximum
Operation Temperature Range	°C	-30	-	+85
Storage Temperature Range	°C	-40	-	+85
Maximum DC Voltage	V	0		
Input Power at Tx Port	dBm	29dBm, Ta=+50°C, 50kh, CW		
Antenna Impedance(single ended)	Ω	50 // 10nH		
Tx Impedance(single ended)	Ω	50 // 33nH		
Rx Impedance (balanced) <sup>(1)</sup>	Ω	100 // 72nH		
Package type		C56		
Length x Width	mm <sup>2</sup>	2.5 x 2.0		
Height	mm	0.7		



Electrical Specification

Tx(782.0MHz) → Ant		Specifications			
Parameters Description	Condition [MHz]	Unit	Minimum	Typical	Maximum
Insertion Loss	777.0 ~ 787.0	dB	-	1.4	3.5
Ripple	777.0 ~ 787.0	dB <sub>p-p</sub>	-	0.5	1.5
VSWR of Ant Port	777.0 ~ 787.0	-	-	1.5	2.2
VSWR of Tx Port	777.0 ~ 787.0	-	-	1.5	2.2
Attenuation	DC ~ 716.0	dB	30	36	-
	716.0 ~ 728.0	dB	30	39	-
	728.0 ~ 746.0	dB	35	43	-
	746.0 ~ 756.0	dB	40	46	-
	758.0 ~ 767.5	dB	18	28	-
	767.5 ~ 768.0	dB	18	26	-
	768.0 ~ 769.0	dB	12	22	-
	769.0 ~ 770.0	dB	10	19	-
	770.0 ~ 771.0	dB	5	16	-
	771.0 ~ 772.0	dB	3	9	-
	793.0 ~ 805.0	dB	-	1.5	-
	869.0 ~ 894.0	dB	30	37	-
	1554.0 ~ 1565.0	dB	30	40	-
	1565.0 ~ 1585.0	dB	30	40	-
	1597.0 ~ 1607.0	dB	30	40	-
	1805.0 ~ 1880.0	dB	30	41	-
	1930.0 ~ 1990.0	dB	30	42	-
2110.0 ~ 2170.0	dB	30	43	-	
2331.0 ~ 2361.0	dB	30	44	-	
2400.0 ~ 2484.0	dB	30	43	-	
3108.0 ~ 3148.0	dB	30	41	-	



SD-075104-C56

Band 13, SAW Duplexer for 751.0 / 782.0MHz

Ant → Rx(751.0MHz)		Specifications			
Parameters Description	Condition [MHz]	Unit	Minimum	Typical	Maximum
Insertion Loss	746.0 ~ 756.0	dB	-	2.3	3.5
Ripple	746.0 ~ 756.0	dB <sub>p-p</sub>	-	0.5	1.5
VSWR of Ant Port	746.0 ~ 756.0	-	-	1.7	2.1
VSWR of Rx Port	746.0 ~ 756.0	-	-	1.7	2.1
Attenuation	DC ~ 736.0	dB	3	6	-
	777.0 ~ 787.0	dB	45	53	-
	793.0 ~ 805.0	dB	45	58	-
	805.0 ~ 6000.0	dB	20	33	-
Amplitude balance( S <sub>31</sub> /S <sub>41</sub>  )	746.0 ~ 756.0	dB	-2	-0.9/+0.9	+2
Phase balance $\Phi(S_{31}) - \Phi(S_{41}) + 180^\circ$	746.0 ~ 756.0	deg	-15	-7/+7	+15

Rx → Tx		Specifications			
Parameters Description	Condition [MHz]	Unit	Minimum	Typical	Maximum
Isolation in Tx Band	777.0 ~ 787.0	dB	50	55	-
Isolation in Rx Band	746.0 ~ 756.0	dB	40	47	-

**Notes :** (1) With Matching Network .

**Package Dimensions**

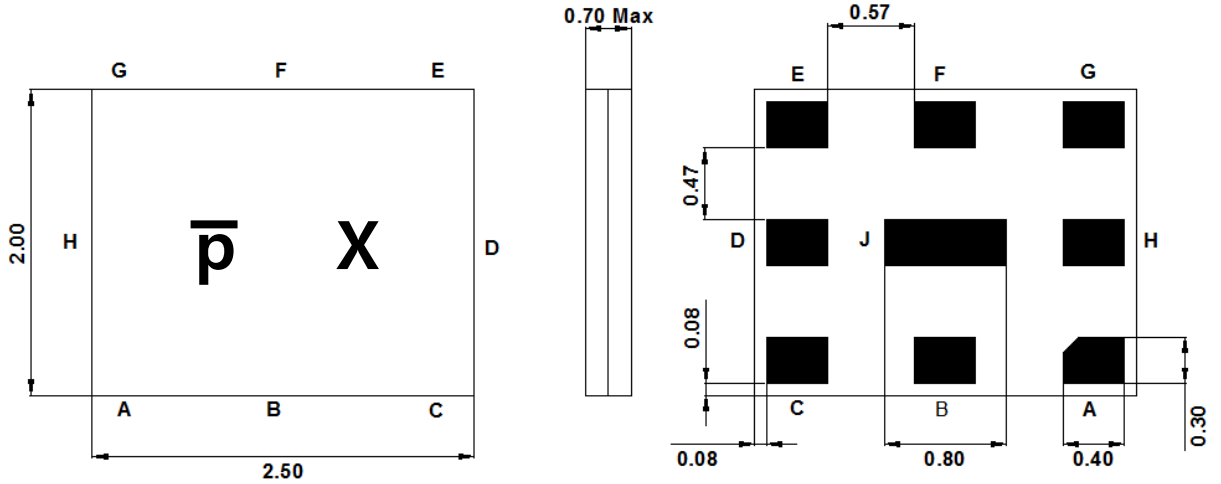

Marking Descriptions	
p	Series Number
X	Date Code(Year+Month)

Pin Description	
B,D,E,G,J	Ground
F	Ant
C	Tx (782.0MHz)
A,H	Rx (751.0MHz)

**Testing Environment**

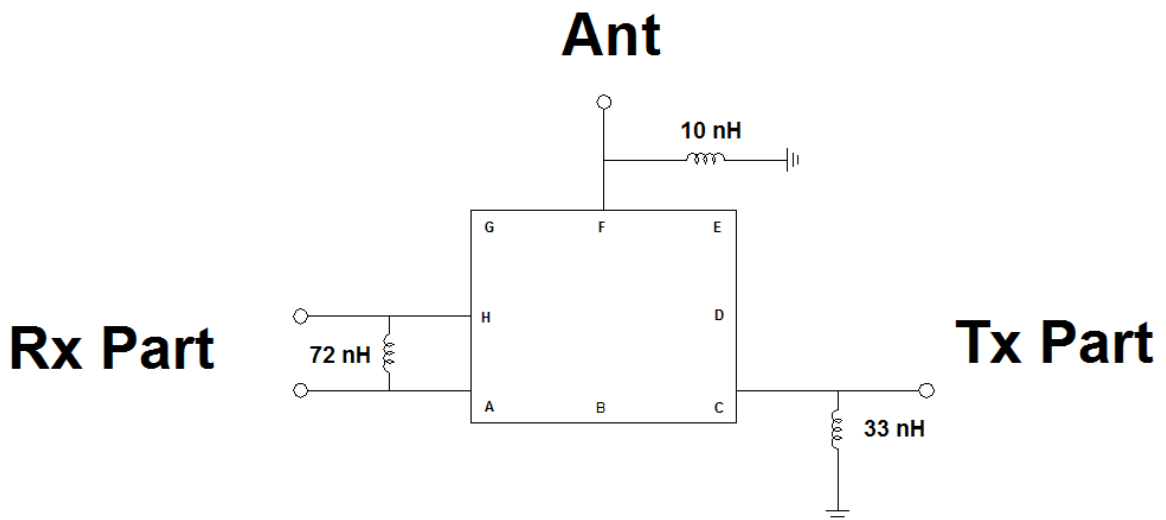

**Frequency Characteristics**

**Tx to Ant**

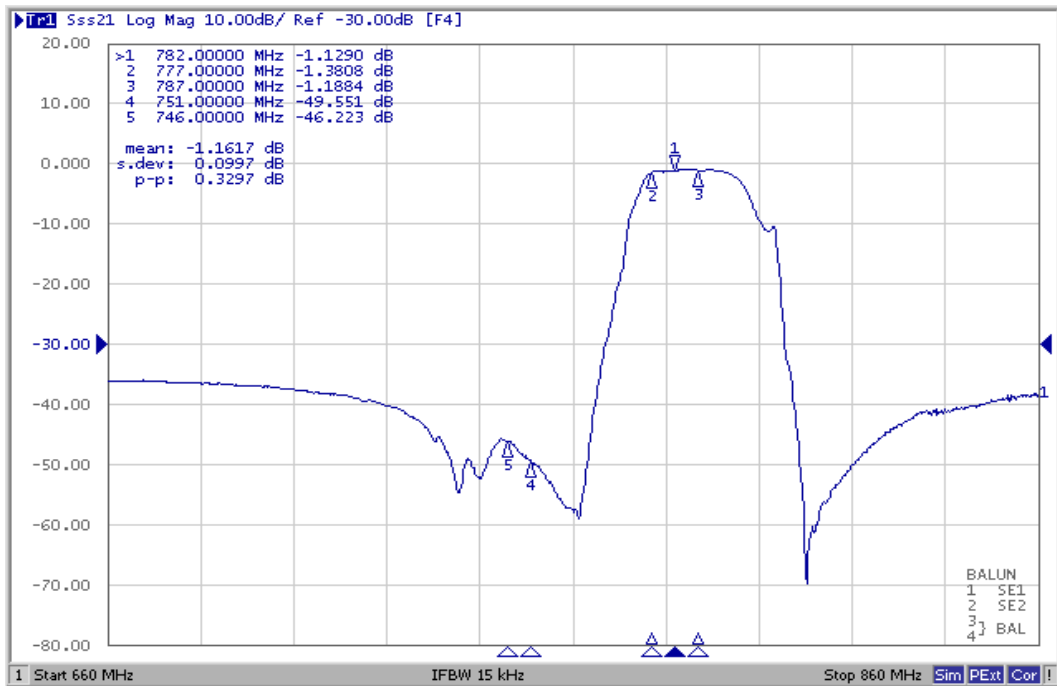

**Ant to Rx**

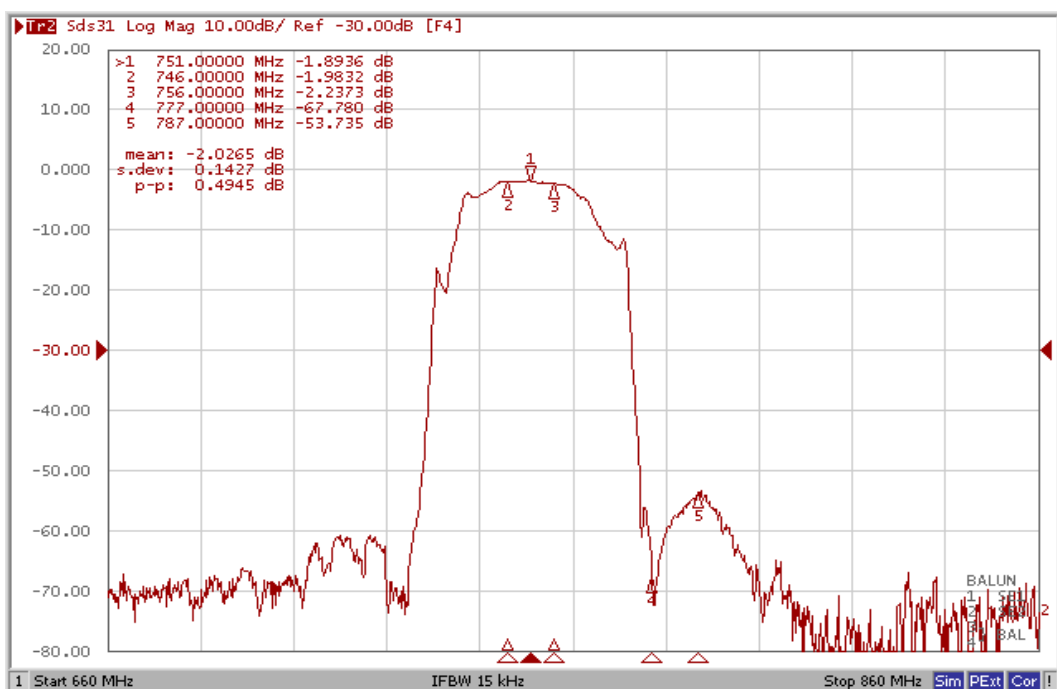

**Isolation**

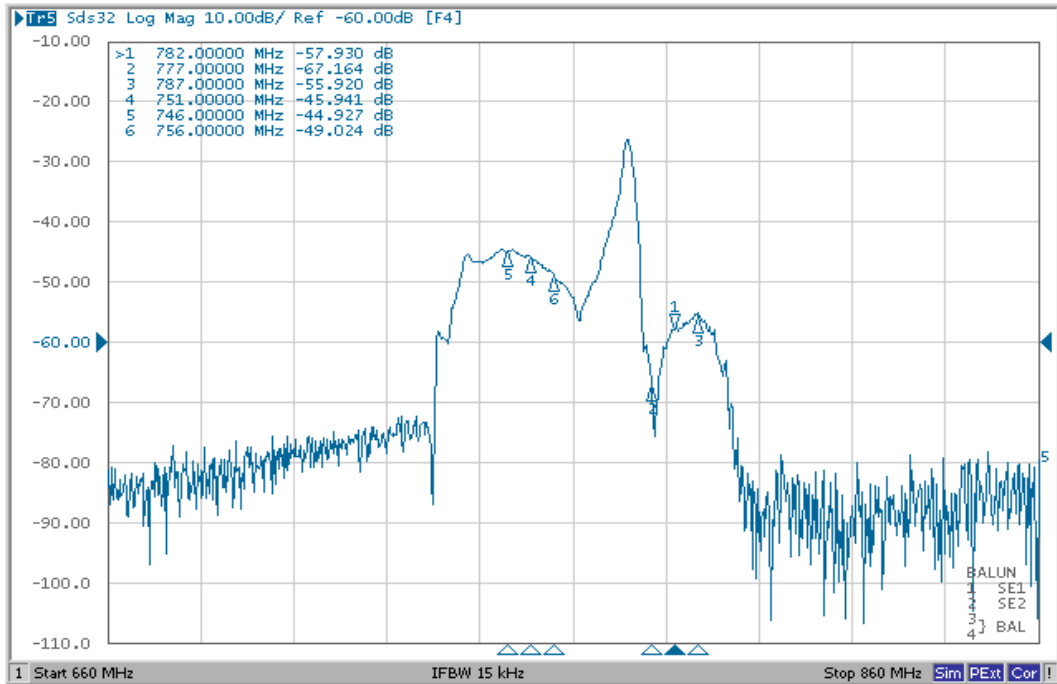

**Ripple**

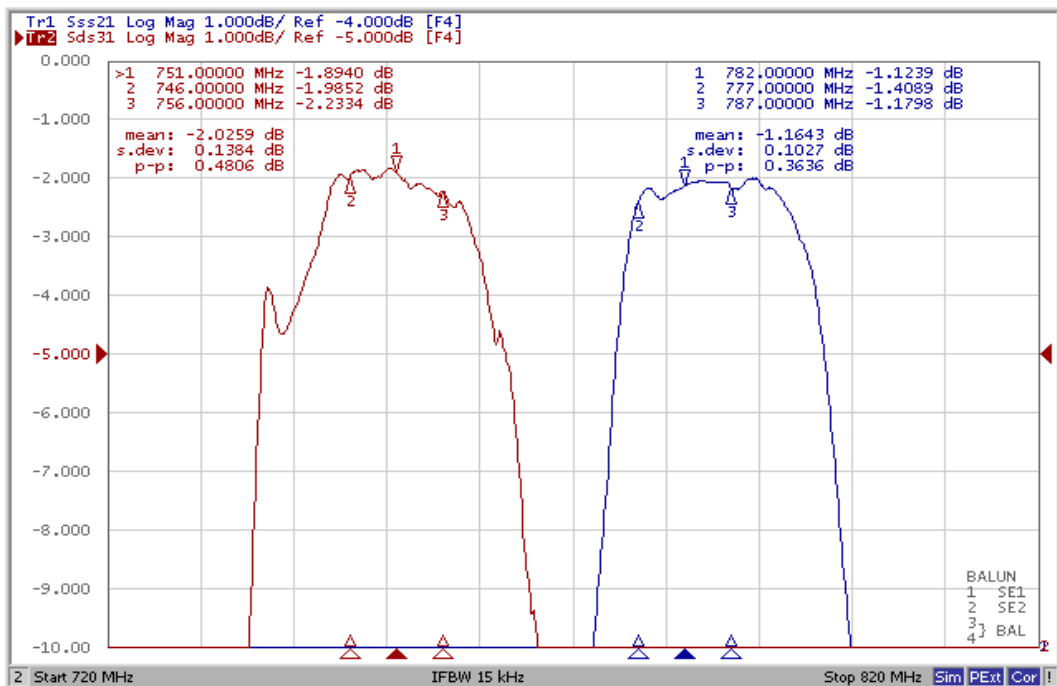



VSWR (Tx Port)

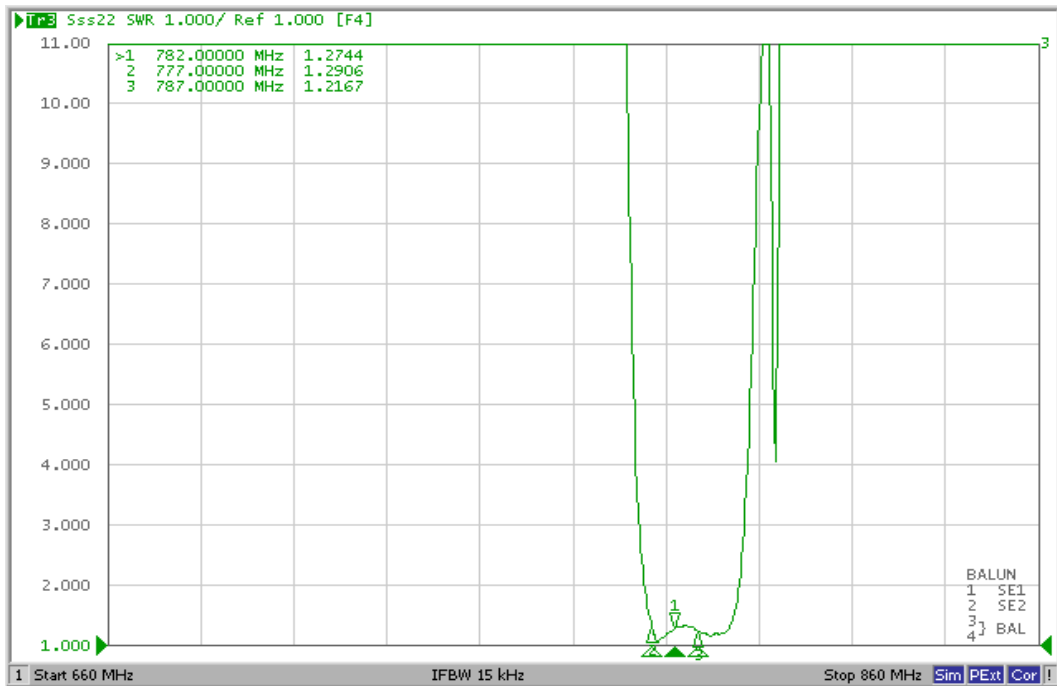

Smith Chart (Tx Port)

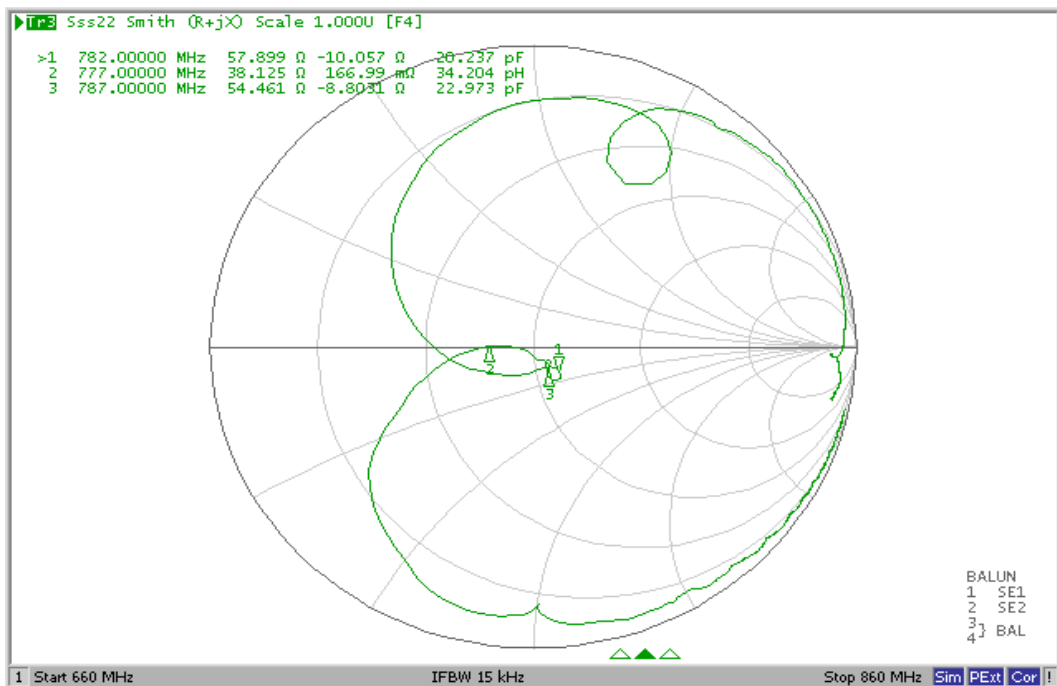





VSWR (Rx Port)



Smith Chart (Rx Port)

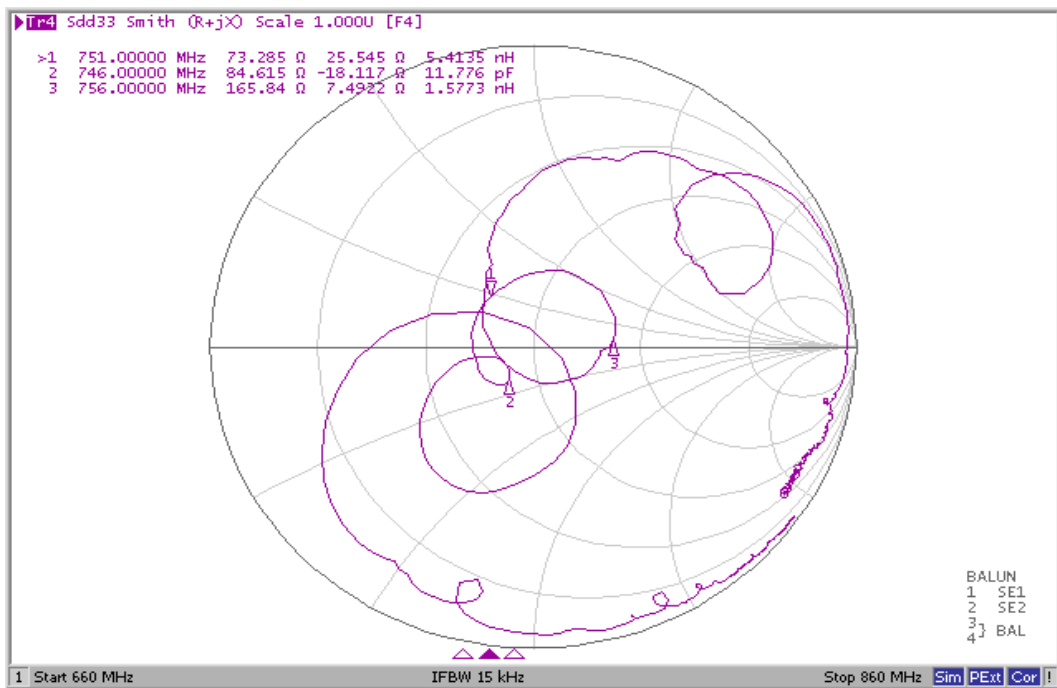

### VSWR (ANT Port)

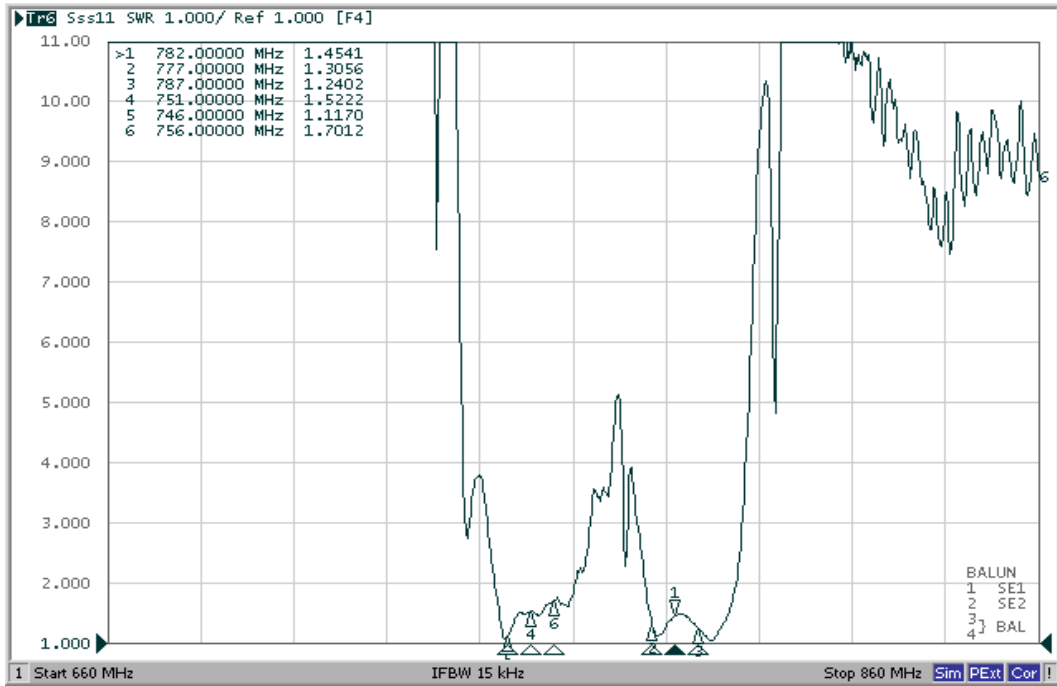

### Smith Chart (ANT Port)

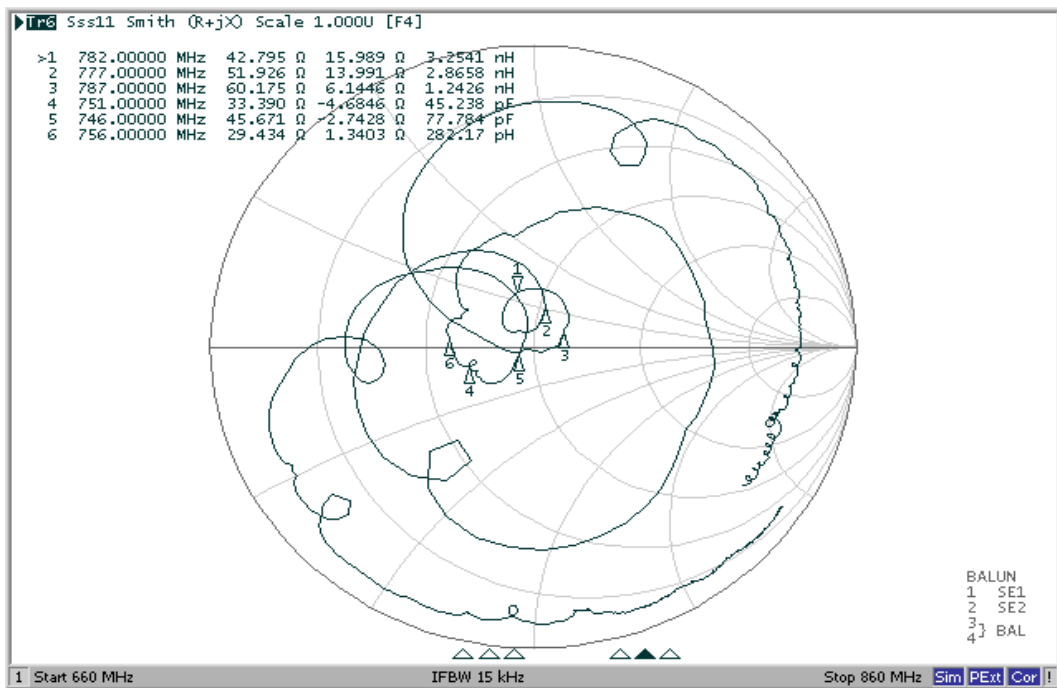



Wide Span

Tx

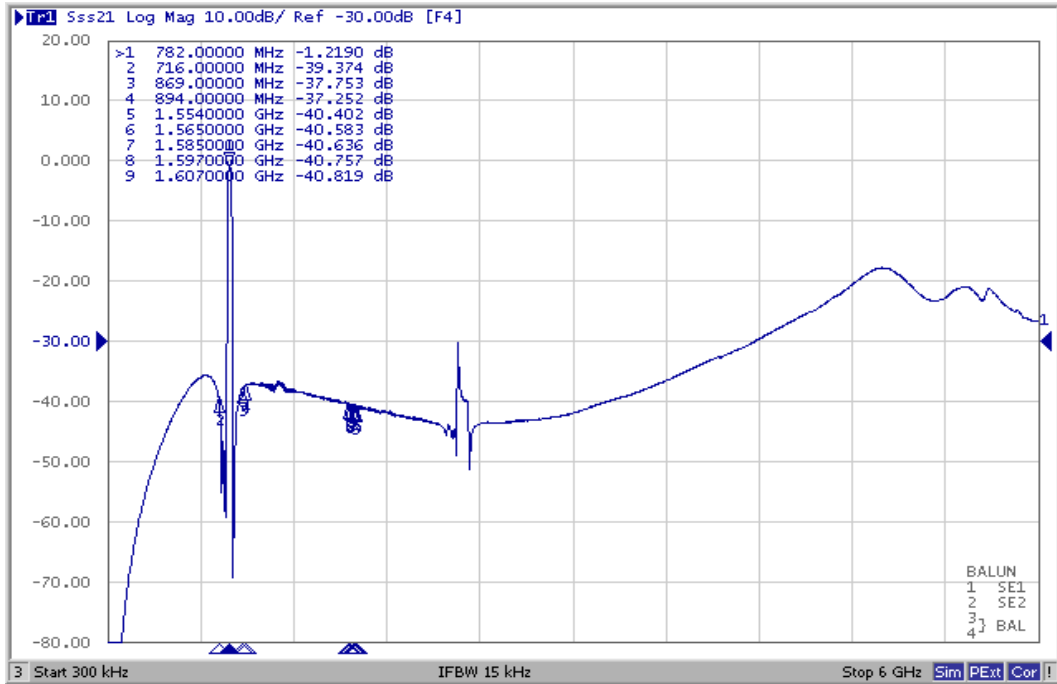

Rx

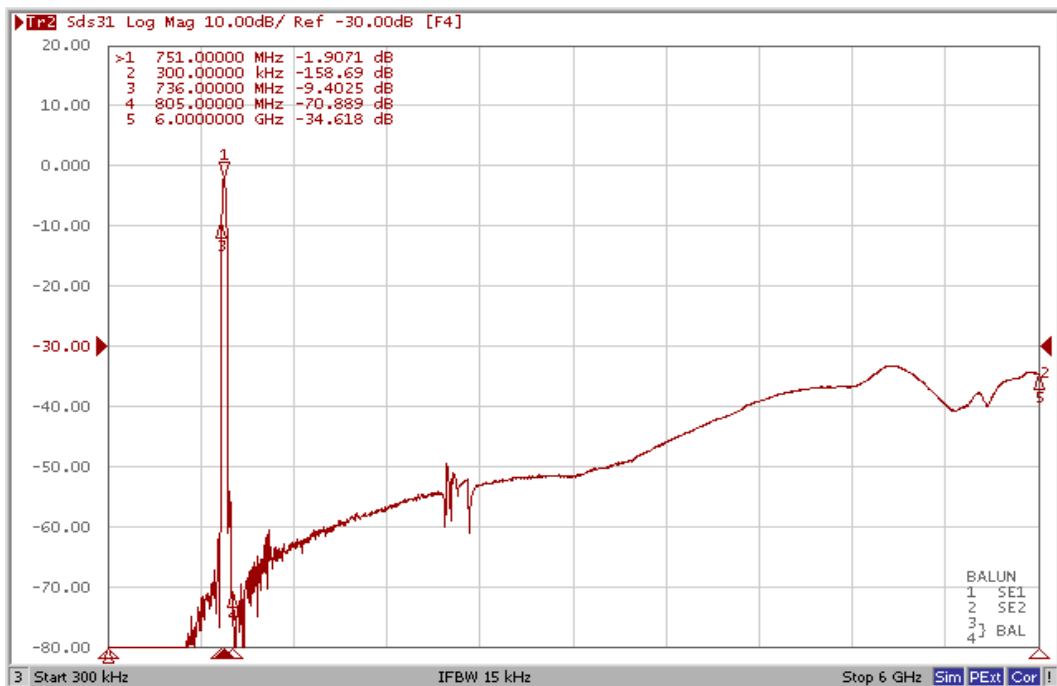



Amplitude balance of Ant to Rx+/Rx-

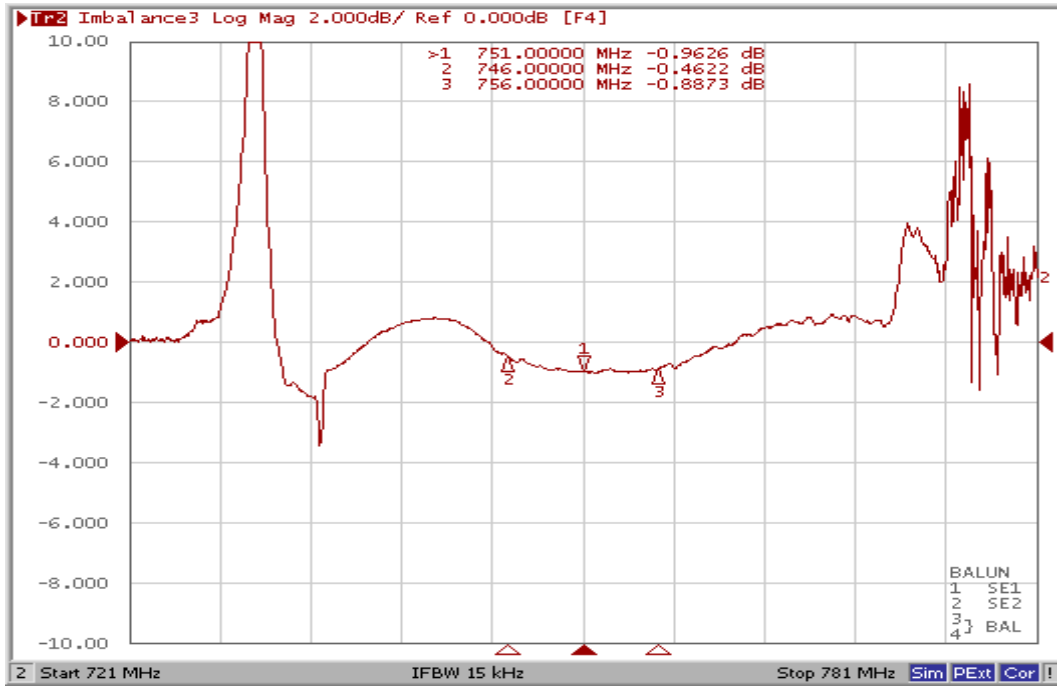

Phase balance of Ant to Rx+/Rx-

