



*Total Solution Provider in Saw Device*

---

# SD-080601-S32

LTE, SAW DUPLEXER For 806 MHz / 847 MHz  
Revision 0: July 2014



- Electrical Characteristics
  - Package Dimensions
  - Testing Environment
  - Frequency Characteristics
- 

**SAWNICS Inc.**

---

460 Cheonheung-ri, Seonggeo-eup, Cheonan-si, Chungcheongnam-do, 330-836 / Korea.  
Tel: +82 41 550 9372 / Fax: +82 41 550 9399 / [www.sawnics.com](http://www.sawnics.com)



**Electrical Characteristics**

**Maximum Ratings**

Parameters Description	Unit	Minimum	Typical	Maximum
Operation Temperature Range	°C	-20	-	+100
Storage Temperature Range	°C	-40	-	+100
Maximum DC Voltage	V	0		
Maximum Input Power	W	1.0 W > 50,000 Hours, CW tone(Ta= +50°C)		
Input Impedance	Ω	50		
Output Impedance	Ω	50		
Package type & size		S32		
Length x Width	mm <sup>2</sup>	-	3.8 x 3.8	-
Height	mm	-	-	1.45

**Electrical Specification**

Uplink → Ant		Specifications			
Parameters Description	Condition [MHz]	Unit	Minimum	Typical	Maximum
Insertion Loss	832.0 ~ 862.0	dB	-	3.0	4.5
Amplitude Ripple	832.0 ~ 862.0	dB <sub>p-p</sub>	-	1.6	2.5
VSWR	832.0 ~ 862.0	-	-	1.7	2.5
Absolute Attenuation	791.0 ~ 821.0	dB	35	45	-

Ant → Downlink		Specifications			
Parameters Description	Condition [MHz]	Unit	Minimum	Typical	Maximum
Insertion Loss	791.0 ~ 821.0	dB	-	2.0	4.5
Amplitude Ripple	791.0 ~ 821.0	dB <sub>p-p</sub>	-	1.2	2.5
VSWR	791.0 ~ 821.0	-	-	1.5	2.5
Absolute Attenuation	832.0 ~ 862.0	dB	25	34	-



Downlink → Uplink		Specifications			
Parameters Description	Condition [MHz]	Unit	Minimum	Typical	Maximum
Isolation	832.0 ~ 862.0	dB	30	35	-
	791.0 ~ 821.0	dB	35	45	-

**Notes :** (1) With Matching Network .

**Package Dimensions**

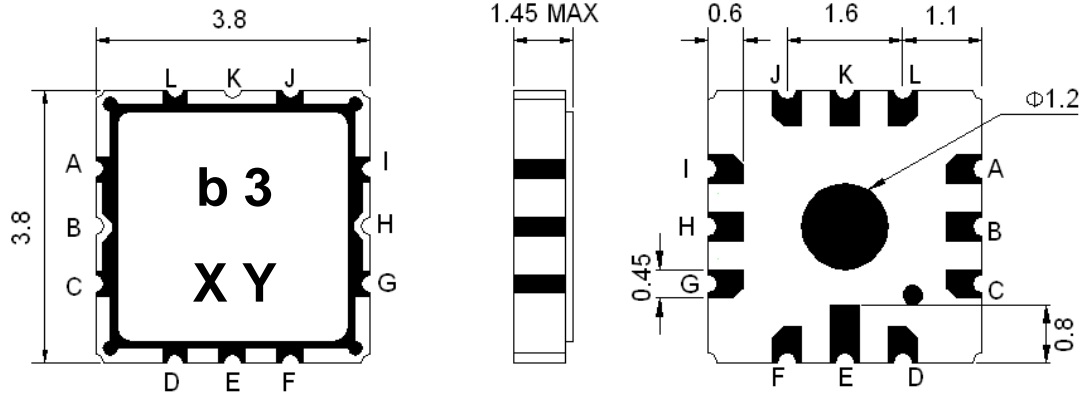

Marking Descriptions	
b	Wireless Application
3	Series Number
X	Date Code(Year)
Y	Date Code(Month)

Pin Description	
A, C, D, E, F, G, I, J, L	Ground
K	Ant
B	Uplink (847.0 MHz)
H	Downlink (806.0MHz)

**Testing Environment**

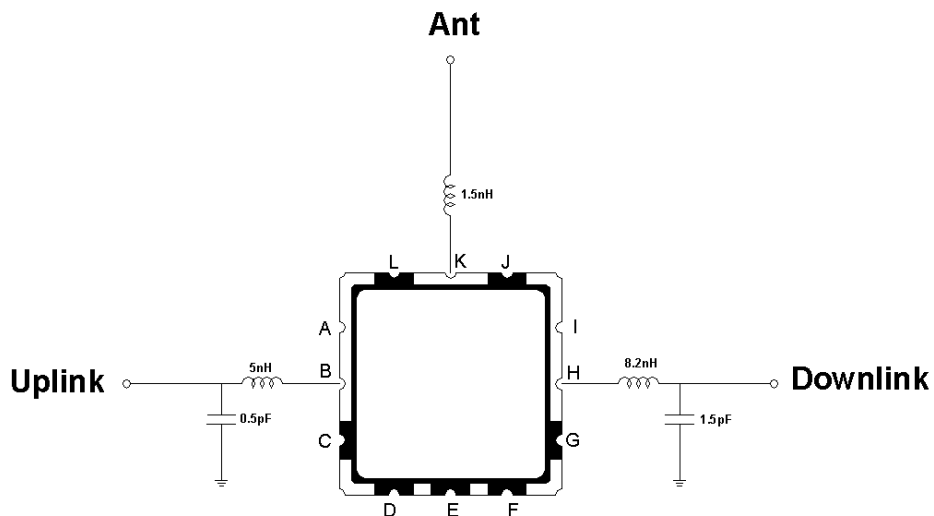

**Frequency Characteristics**

**Uplink to Ant**

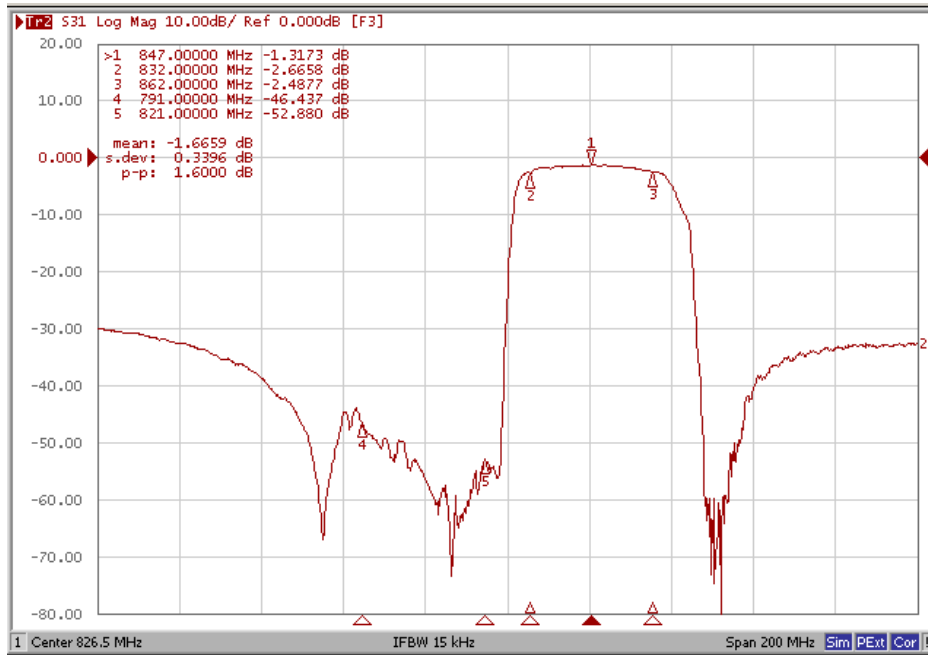

**Ant to Downlink**

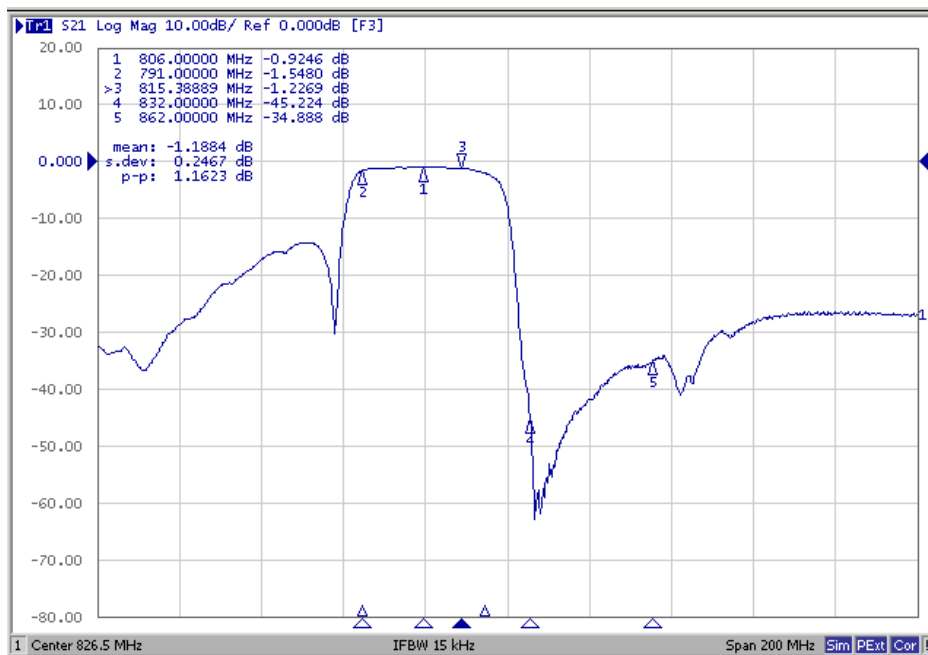



Isolation

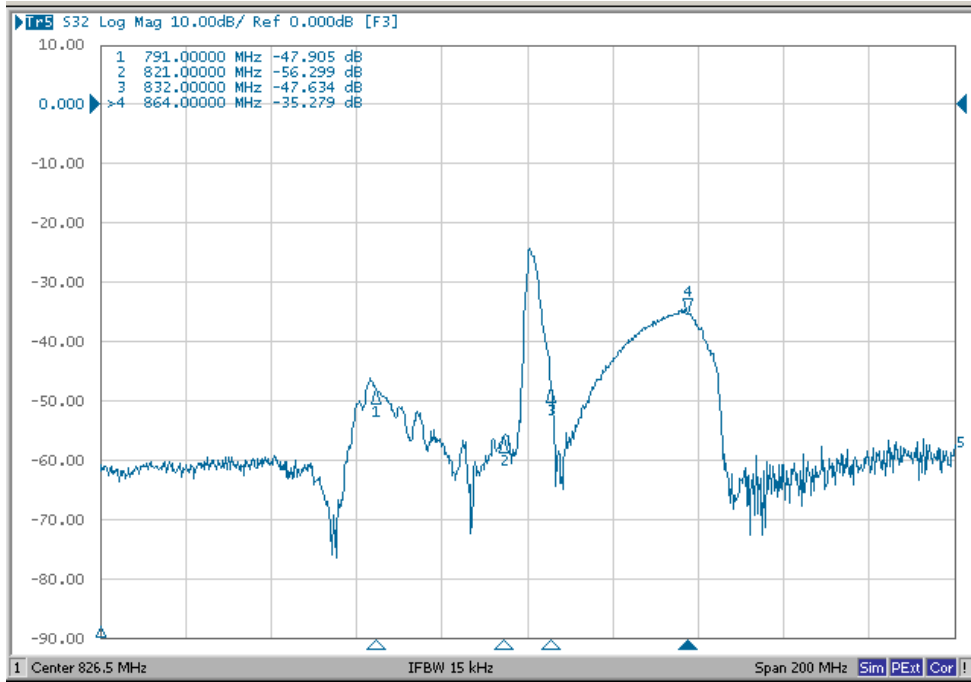

Uplink

Smith Chart

VSWR

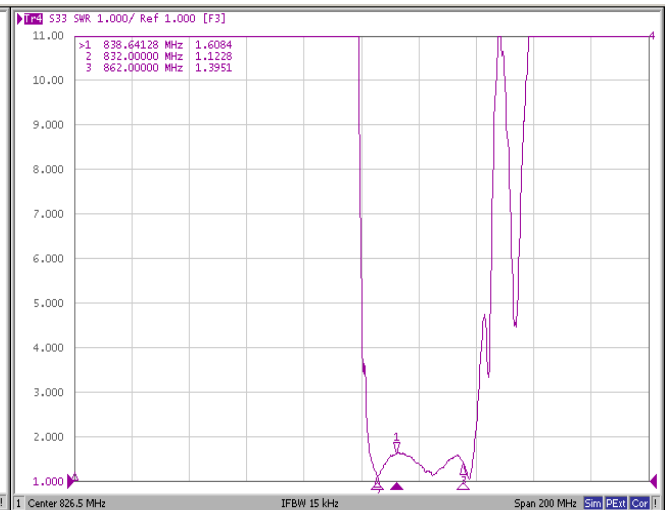
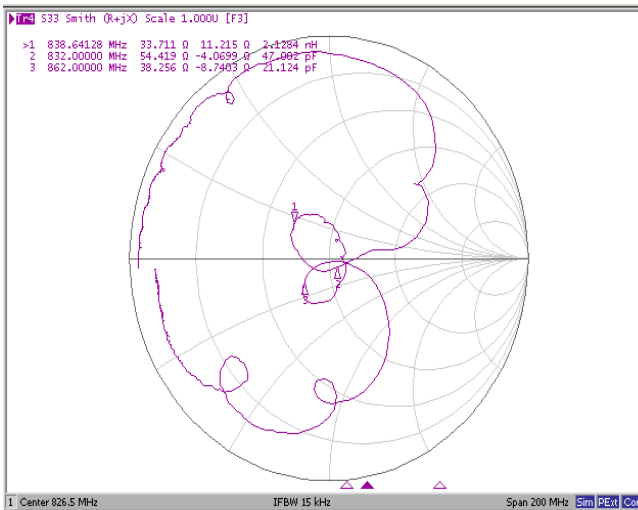



Downlink

Smith Chart

VSWR

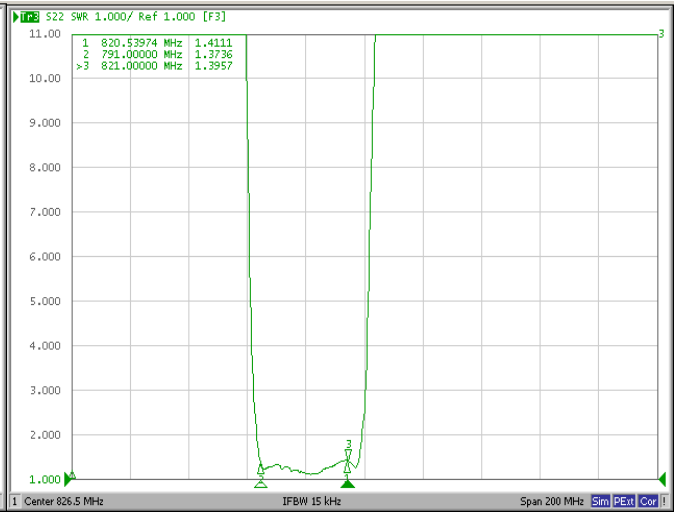
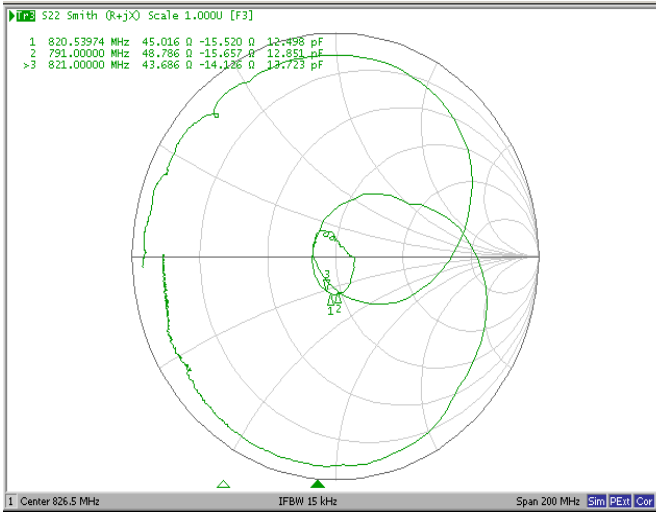

Antenna

Smith Chart

VSWR

