



Total Solution Provider in Saw Device

SD-172501-C34

SAW DUPLEXER For 1725.0 MHz / 1820.0MHz
Revision 0: September 2013



- Electrical Characteristics
 - Package Dimensions
 - Testing Environment
 - Frequency Characteristics
-

SAWNICS Inc.

460 Cheonheung-ri, Seonggeo-eup, Cheonan-si, Chungcheongnam-do, 330-836 / Korea.
Tel: +82 41 550 9372 / Fax: +82 41 550 9399 / www.sawnics.com



Electrical Characteristics

Maximum Ratings

Parameters Description	Unit	Minimum	Typical	Maximum
Operation Temperature Range	°C	-10	-	+60
Storage Temperature Range	°C	-40	-	+85
Maximum DC Voltage	V	0		
Maximum Input Power	dBm	28dBm > 50,000 Hours, CW tone(Ta= +50°C)		
Input Impedance	Ω	50		
Output TX Impedance	Ω	50		
Output RX Impedance	Ω	50		
Package type & size	S34			
Length x Width	mm ²	-	3.8 x 3.8	-
Height	mm	-	-	1.45

Electrical Specification

Tx → Ant		Specifications			
Parameters Description	Condition [MHz]	Unit	Minimum	Typical	Maximum
Insertion Loss	1715.0 ~ 1735.0	dB	-	1.5	3.0
Amplitude Ripple	1715.0 ~ 1735.0	dB _{p-p}	-	0.3	1.0
VSWR	1715.0 ~ 1735.0	-	-	1.5	2.0
Absolute Attenuation	1810.0 ~ 1830.0	dB	45	53	-

Ant → Rx		Specifications			
Parameters Description	Condition [MHz]	Unit	Minimum	Typical	Maximum
Insertion Loss	1810.0 ~ 1830.0	dB	-	1.8	3.0
Amplitude Ripple	1810.0 ~ 1830.0	dB _{p-p}	-	0.5	1.0
VSWR	1810.0 ~ 1830.0	-	-	1.5	2.0
Absolute Attenuation	1715.0 ~ 1735.0	dB	38	42	-



Rx → Tx		Specifications			
Parameters Description	Condition [MHz]	Unit	Minimum	Typical	Maximum
Isolation	1715.0 ~ 1735.0	dB	40	45	-
	1810.0 ~ 1830.0	dB	40	53	-

Notes : (1) With Matching Network .

Package Dimensions

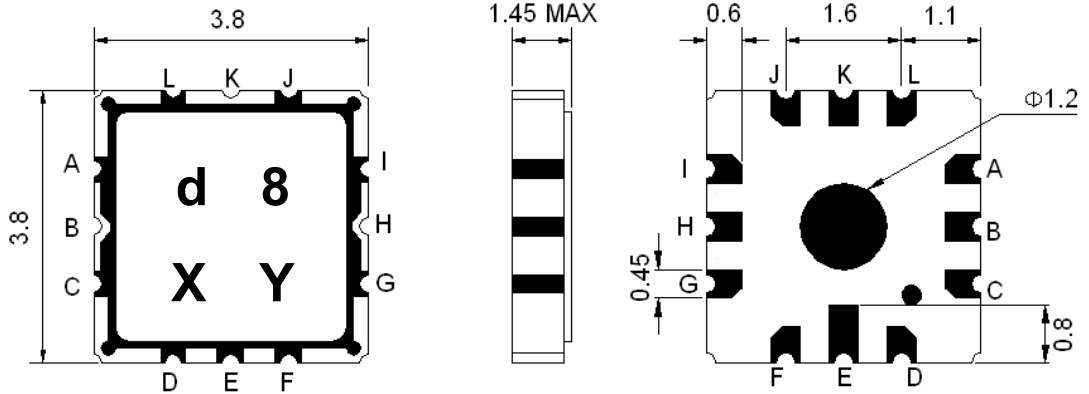

Marking Descriptions	
d	Wireless Application
8	Series Number
X	Date Code(Year)
Y	Date Code(Month)

Pin Description	
A, C, D, E, F, G, I, J, L	Ground
K	Ant
B	Tx (1725.0MHz)
H	Rx (1820.0MHz)

Testing Environment

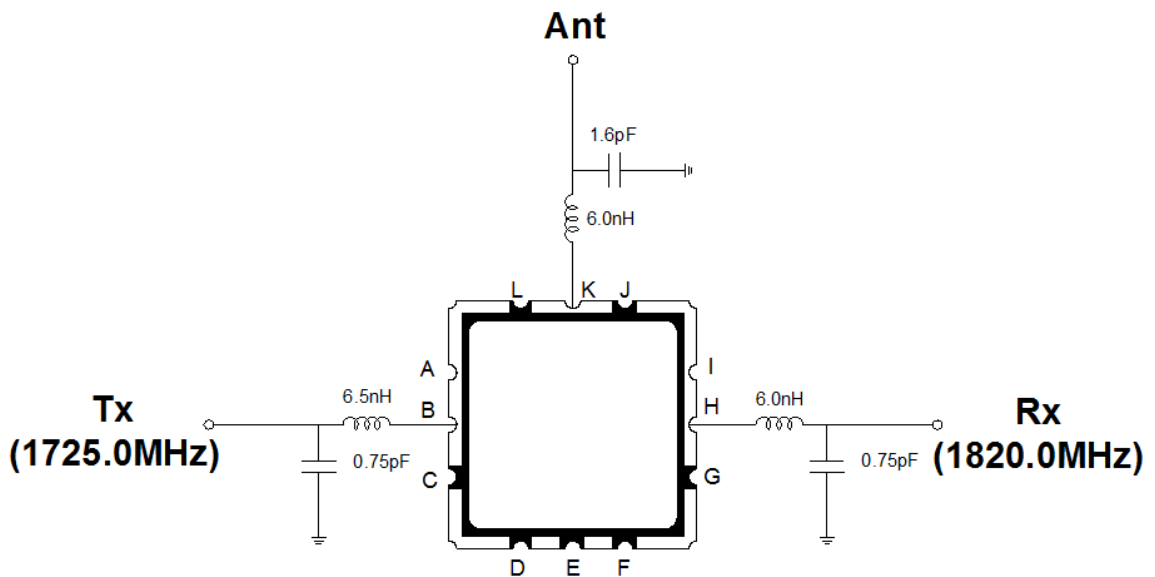

□ Frequency Characteristics

T_x to Ant

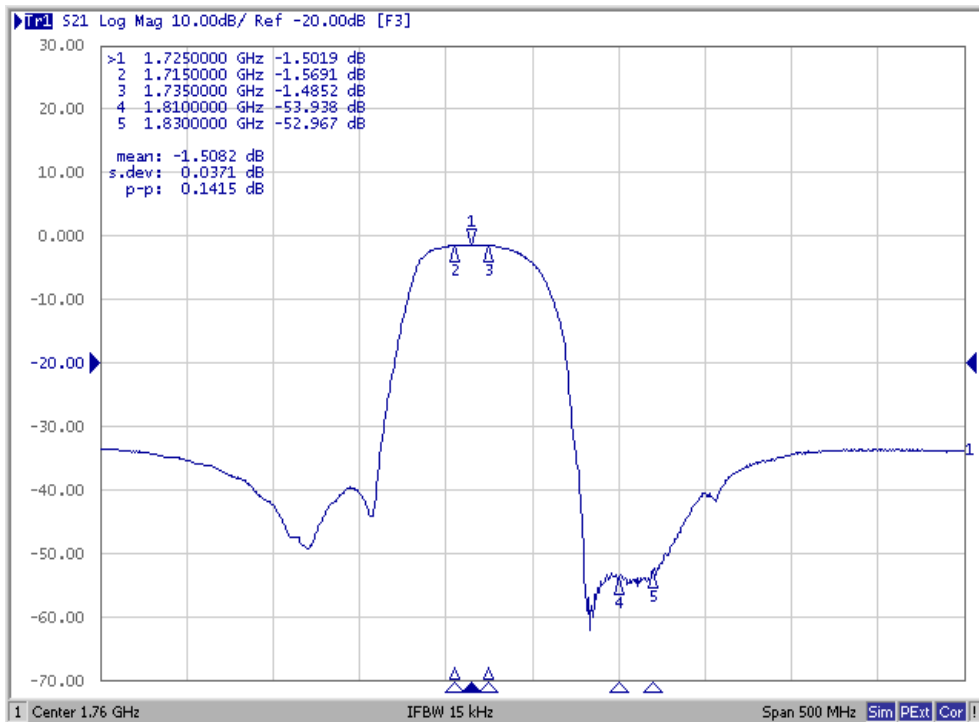

Ant to Rx

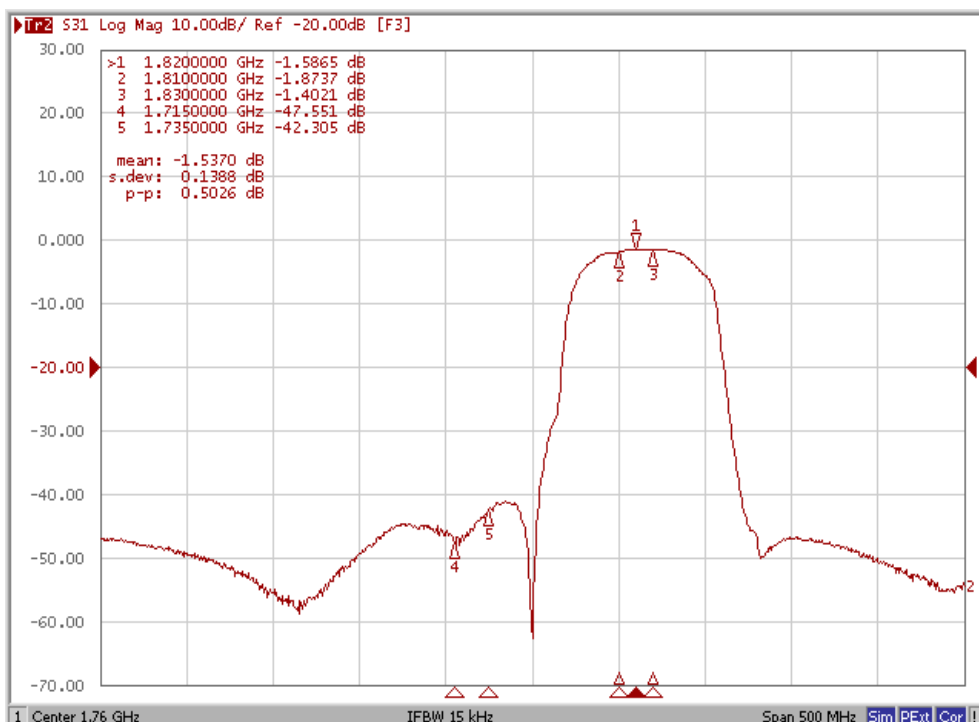



Isolation

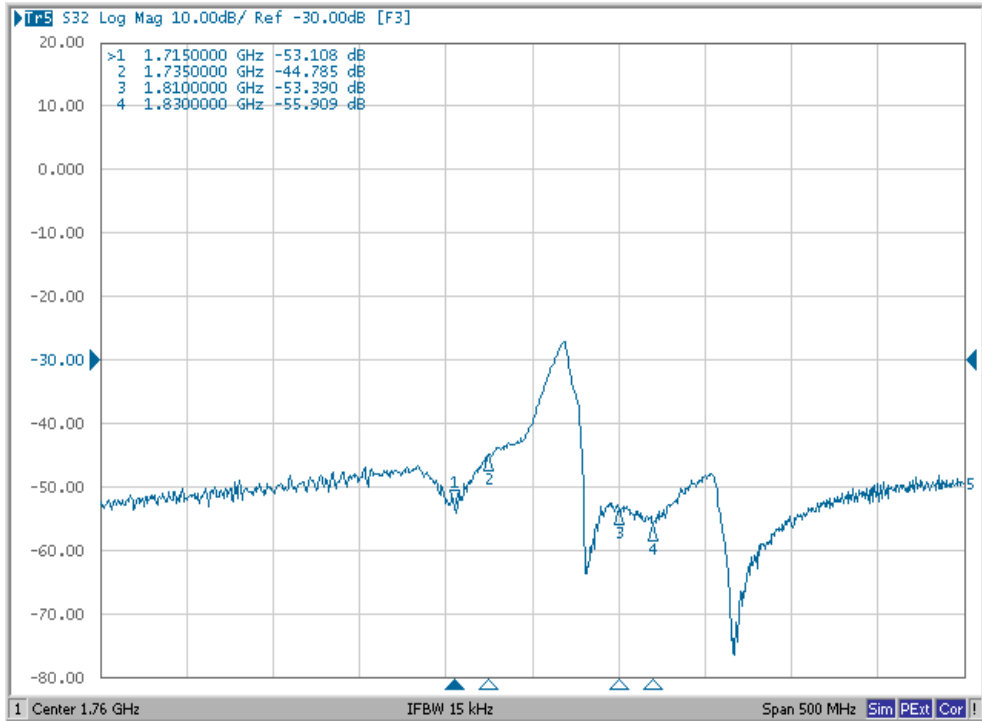

Tx Part

Smith Chart

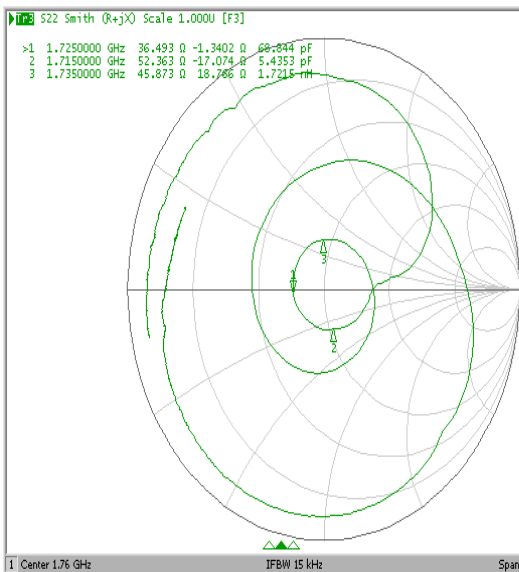

VSWR

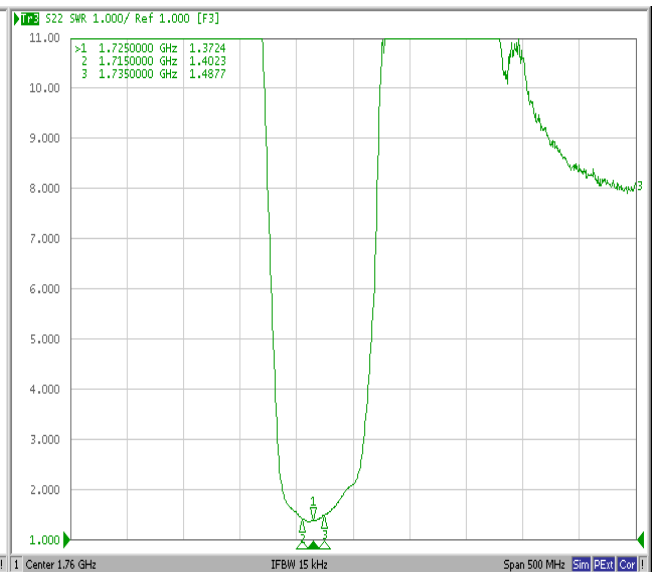



Rx Part

Smith Chart

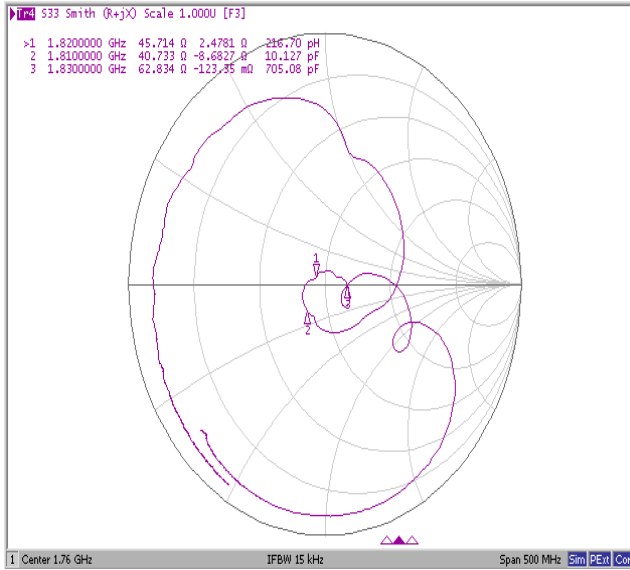

VSWR



Antenna

Smith Chart

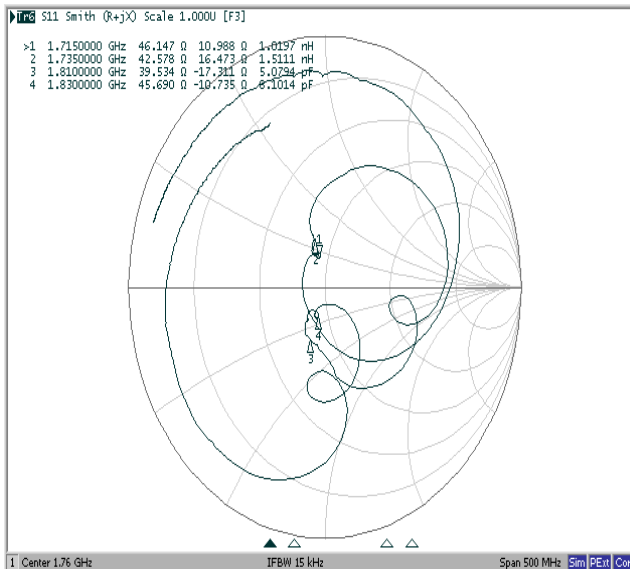

VSWR

