



*Total Solution Provider in Saw Device*

---

# SD412EK6

CDMA 450 Rx Balanced SAW DUPLEXER

For 412.5 MHz / 422.5 MHz

Revision 0: July 2011



- Electrical Characteristics
  - Package Dimensions
  - Testing Environment
  - Frequency Characteristics
- 

**SAWNICS Inc.**

460 Cheonheung-ri, Seonggeo-eup, Cheonan-si, Chungcheongnam-do, 330-836 / Korea.  
Tel: +82 41 550 9372 / Fax: +82 41 550 9399 / [www.sawnics.com](http://www.sawnics.com)



### Electrical Characteristics

#### Maximum Ratings

Parameters Description	Unit	Minimum	Typical	Maximum
Operation Temperature Range	°C	-30	-	+85
Storage Temperature Range		-40	-	+85
Maximum DC Voltage	V	0		
Input Power Level	dBm	29dBm> 50000 Hours, CW tone(Ta= +55°C)		
Antenna & Tx Impedance(single ended)	Ω	50		
Rx Impedance (balanced) <sup>(1)</sup>	Ω	100		
Package type		K6		
Length x Width	mm <sup>2</sup>	5.0 x 5.0		
Height	mm	1.8		

#### Electrical Specification

Tx → Ant		Specifications			
Parameters Description	Condition [MHz]	Unit	Minimum	Typical	Maximum
Insertion Loss	410.0 ~ 415.0	dB	-	2.6	3.3
VSWR	410.0 ~ 415.0	-	-	1.7	2.2
Absolute Attenuation	0.3 ~ 400.0	dB	25	32	-
	420.0 ~ 425.0	dB	40	45	-
	425.0 ~ 1700.0	dB	15	18	-
	1700.0 ~ 2000.0	dB	10	17	-

**SD412EK6****CDMA450 Rx Balanced SAW DUPLEXER FOR 412.5 MHz / 422.5MHz**

Ant → Rx		Specifications			
Parameters Description	Condition [MHz]	Unit	Minimum	Typical	Maximum
Insertion Loss	420.0 ~ 425.0	dB	-	3.2	3.8
Amplitude Imbalance	420.0 ~ 425.0	dB	-1.0	-0.6/0.4	1.0
Phase Imbalance	420.0 ~ 425.0	deg	-10	6.0/7.5	10
VSWR	420.0 ~ 425.0	-	-	2.0	2.5
Absolute Attenuation	0.3 ~ 410.0	dB	45	53	-
	410.0 ~ 415.0	dB	45	53	-
	445.0 ~ 600.0	dB	40	50	-
	600.0 ~ 1200.0	dB	30	40	-
	1200.0 ~ 2000.0	dB	25	32	-

Tx → Rx		Specifications			
Parameters Description	Condition [MHz]	Unit	Minimum	Typical	Maximum
Isolation	410.0 ~ 415.0	dB	52	60	-
	420.0 ~ 425.0	dB	52	70	-

**Notes :** (1) With Matching Network .

**Package Dimensions**

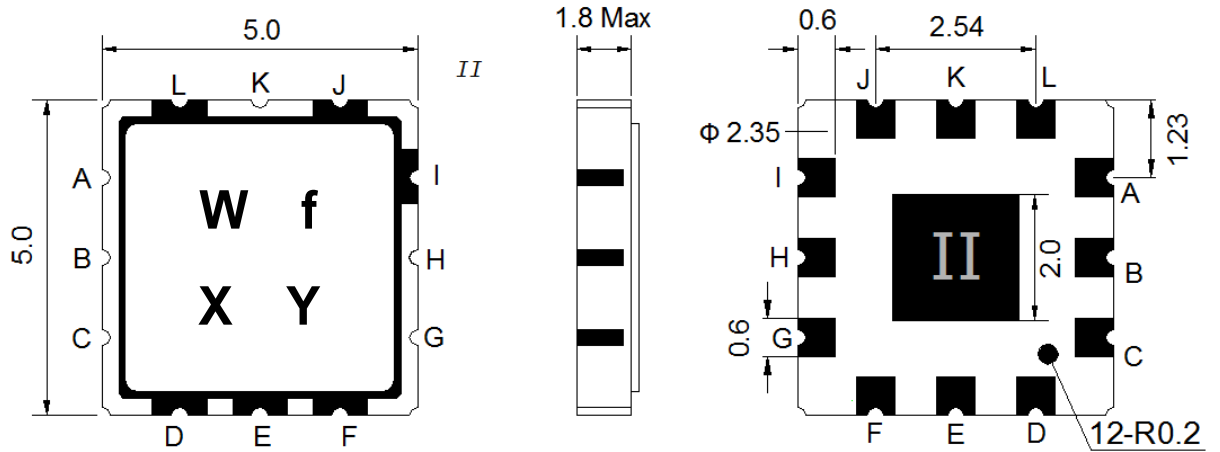

Marking Descriptions	
W	CDMA450 Application
f	Series Number
X	Date Code(Year)
Y	Date Code(Month)

Pin Description	
A, C, D, E, F, I, J, L	Ground
K	Antenna
B	Tx
G, H	Rx Balanced

**Testing Environment**

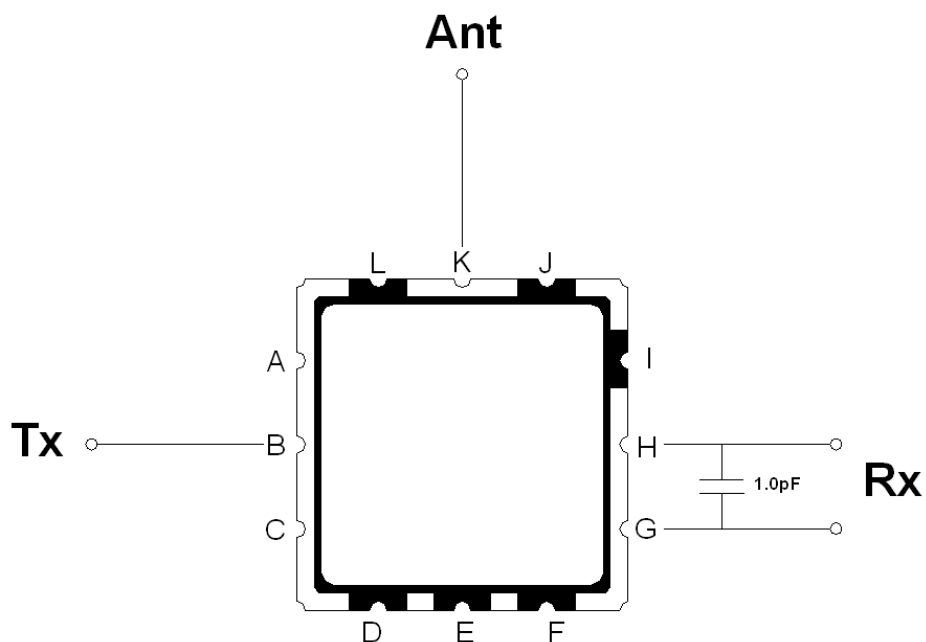



### □ Frequency Characteristics

Tx to Ant

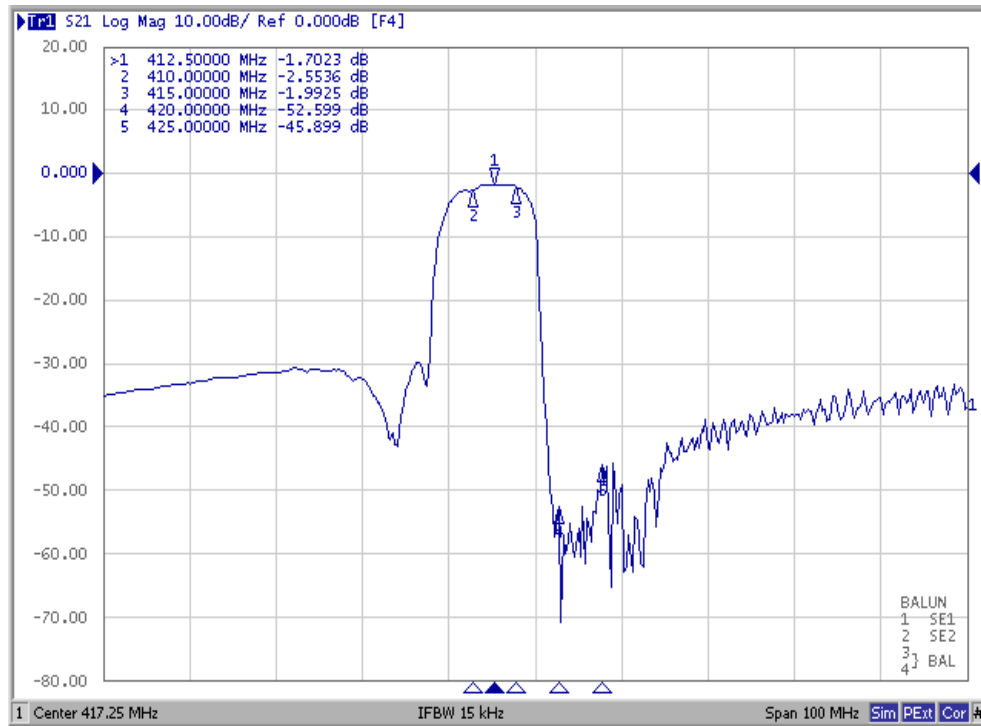

Ant to Rx

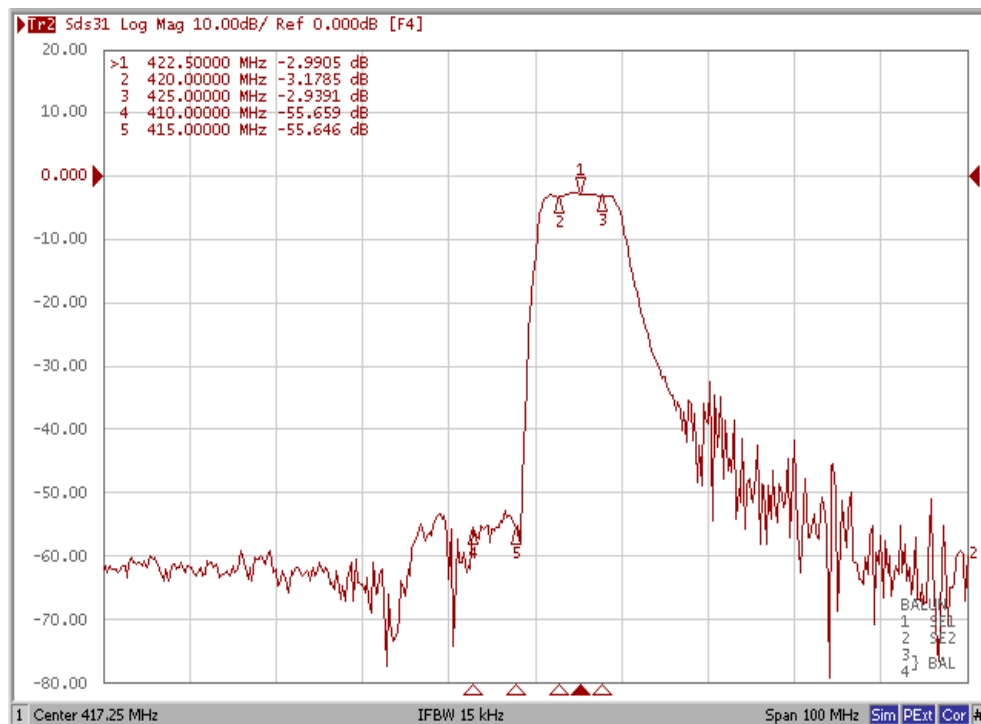



Isolation

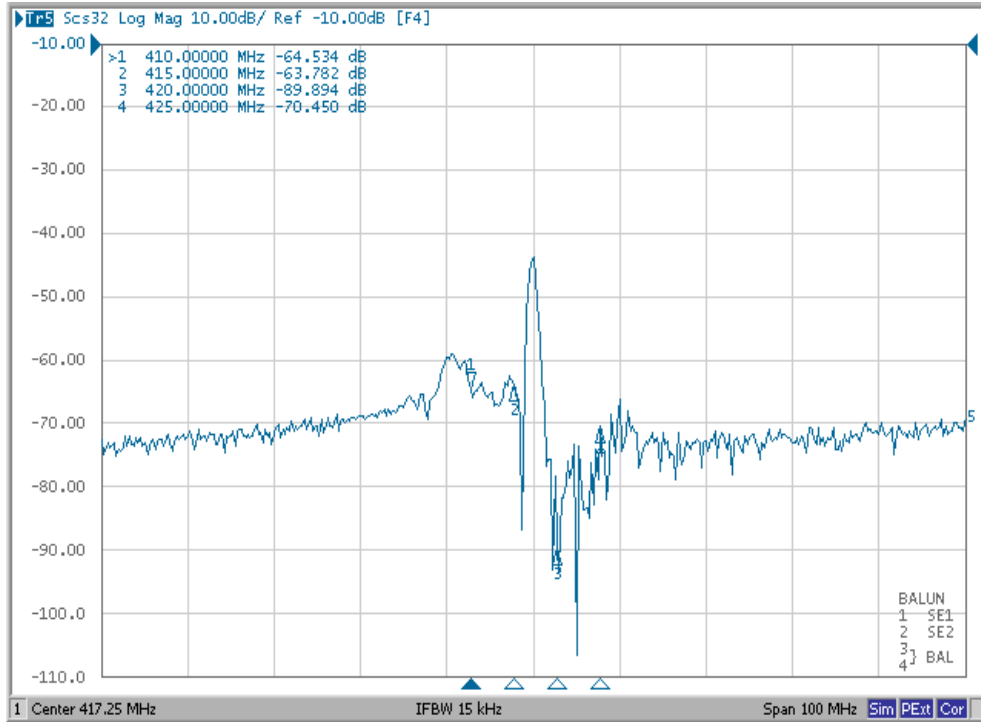

Tx Port

Smith Chart

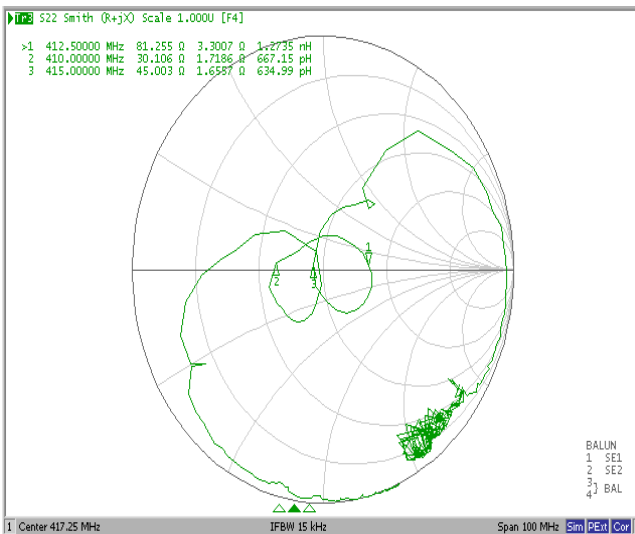

VSWR

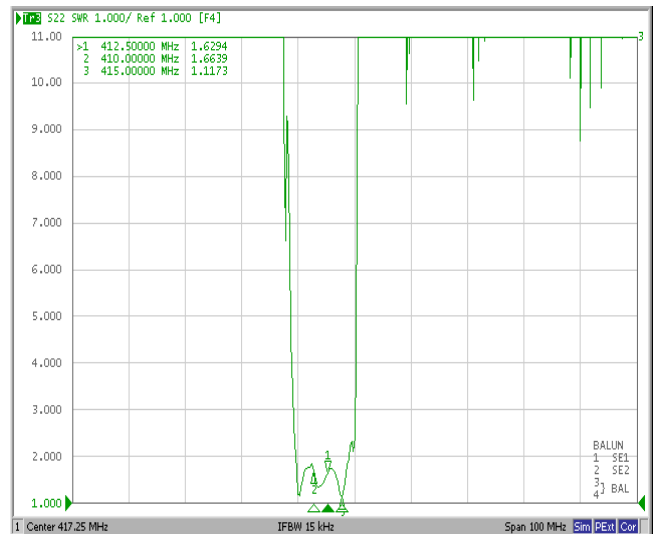

### Rx Port

Smith Chart

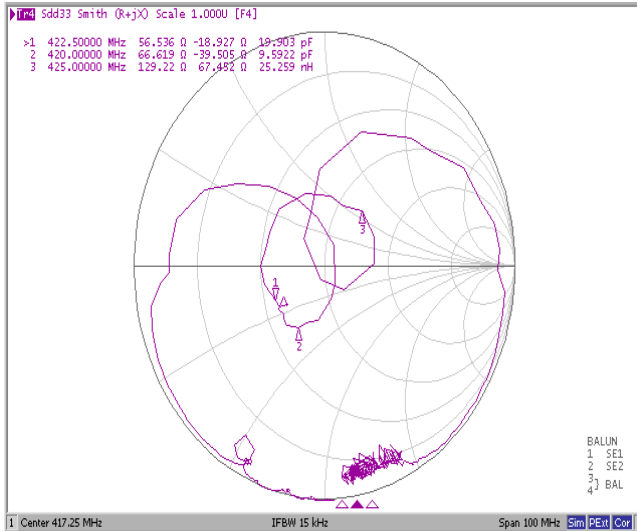

VSWR

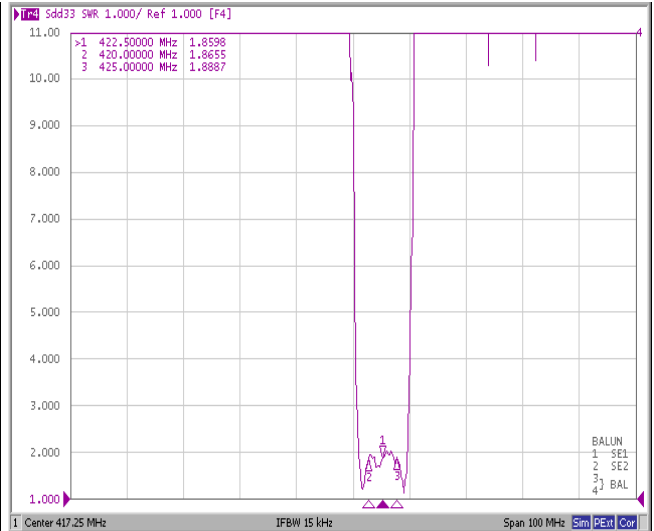

### Ant Port

Smith Chart

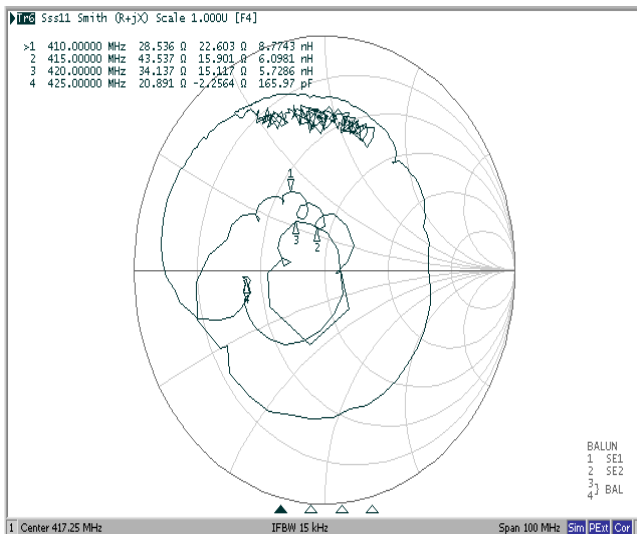

VSWR

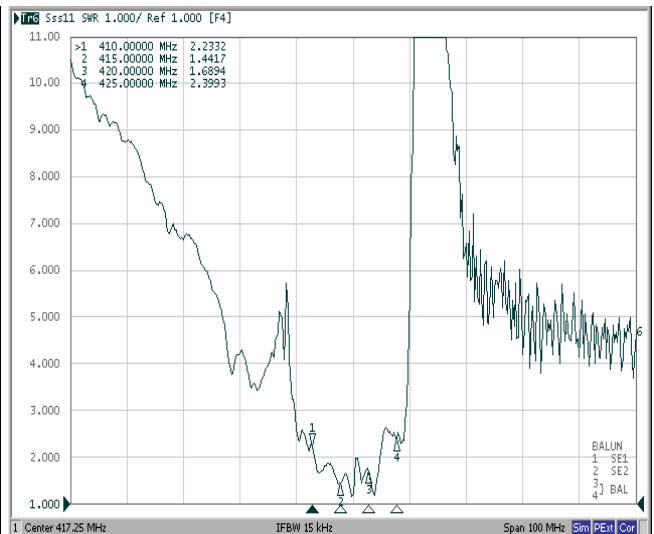



Wide Span

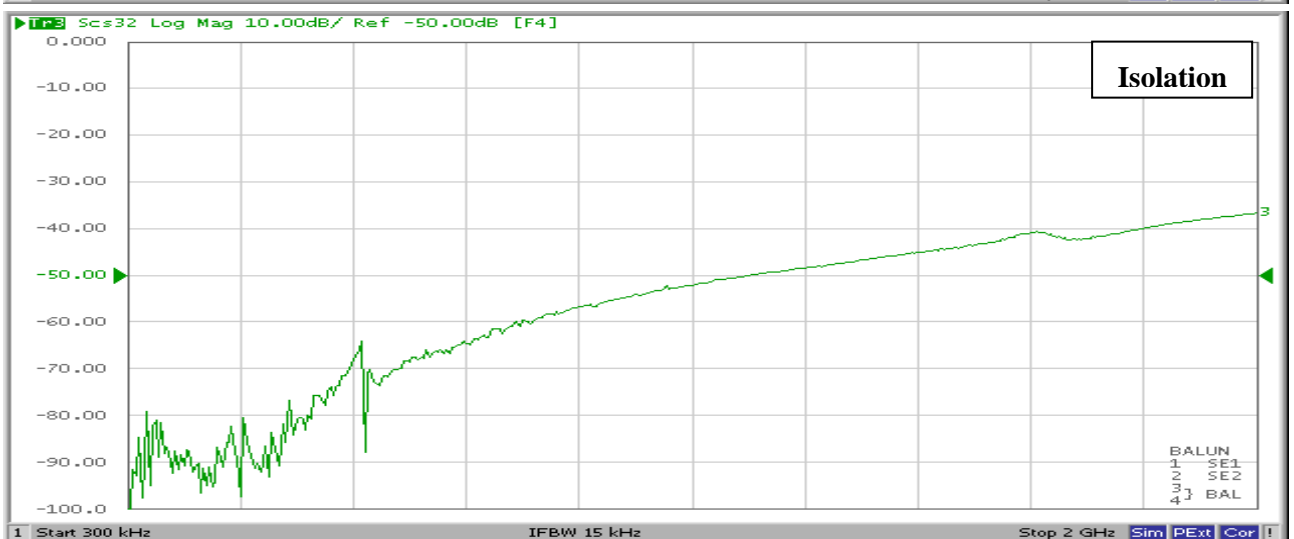
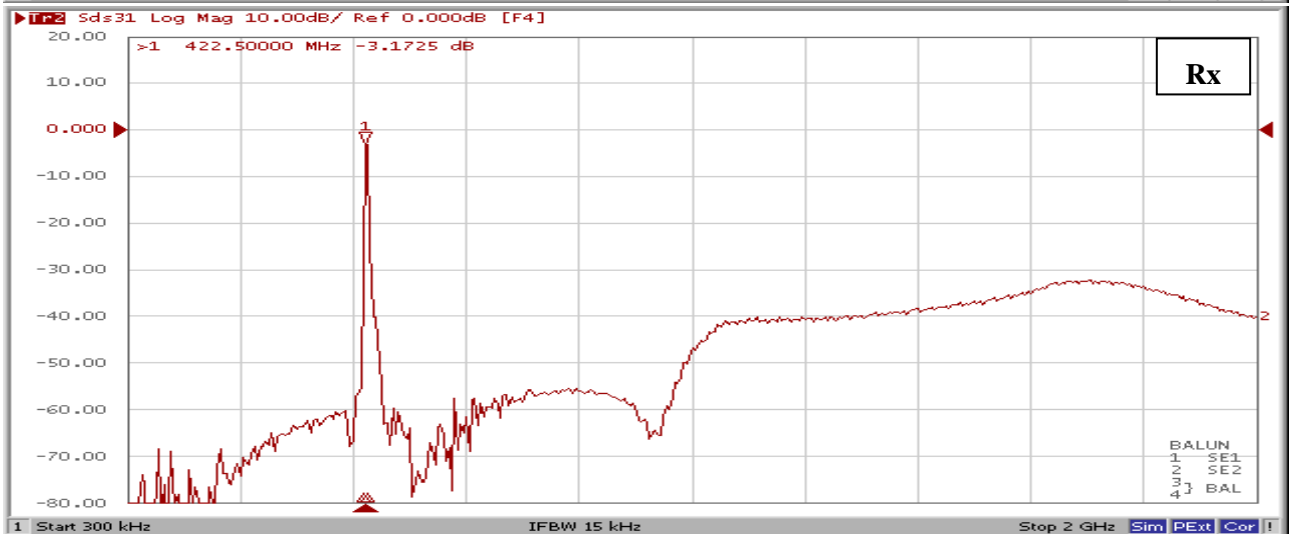
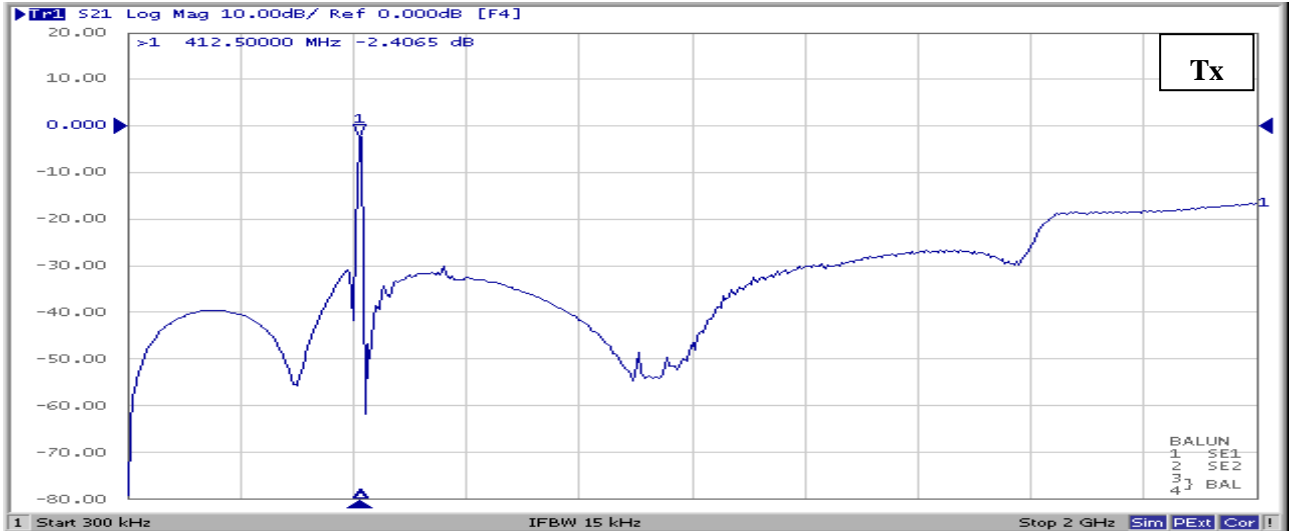





Amplitude Imbalance



Phase Imbalance

